

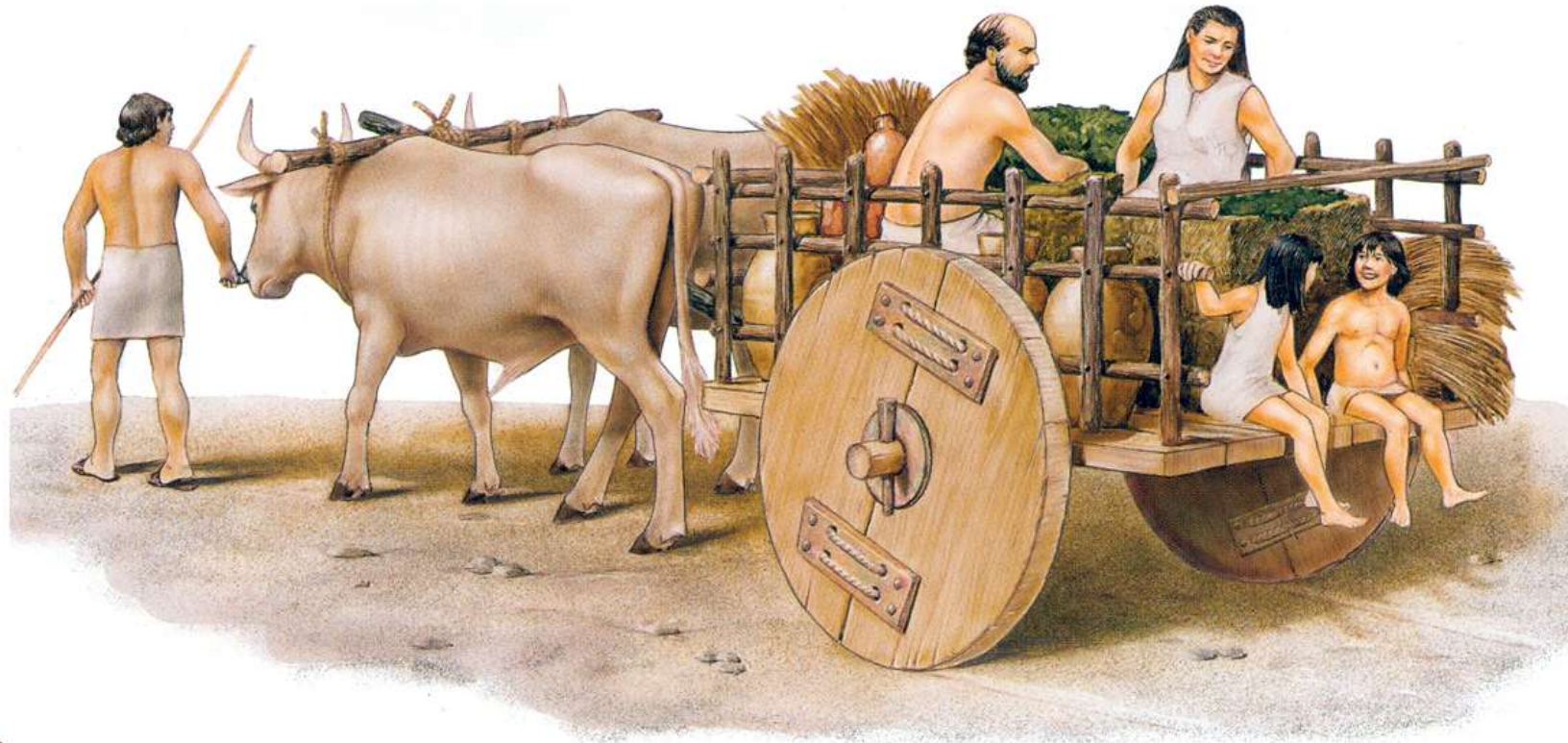

Proto-Cuneiform Signs

by

Ashur Cherry



Proto-Cuneiform Signs

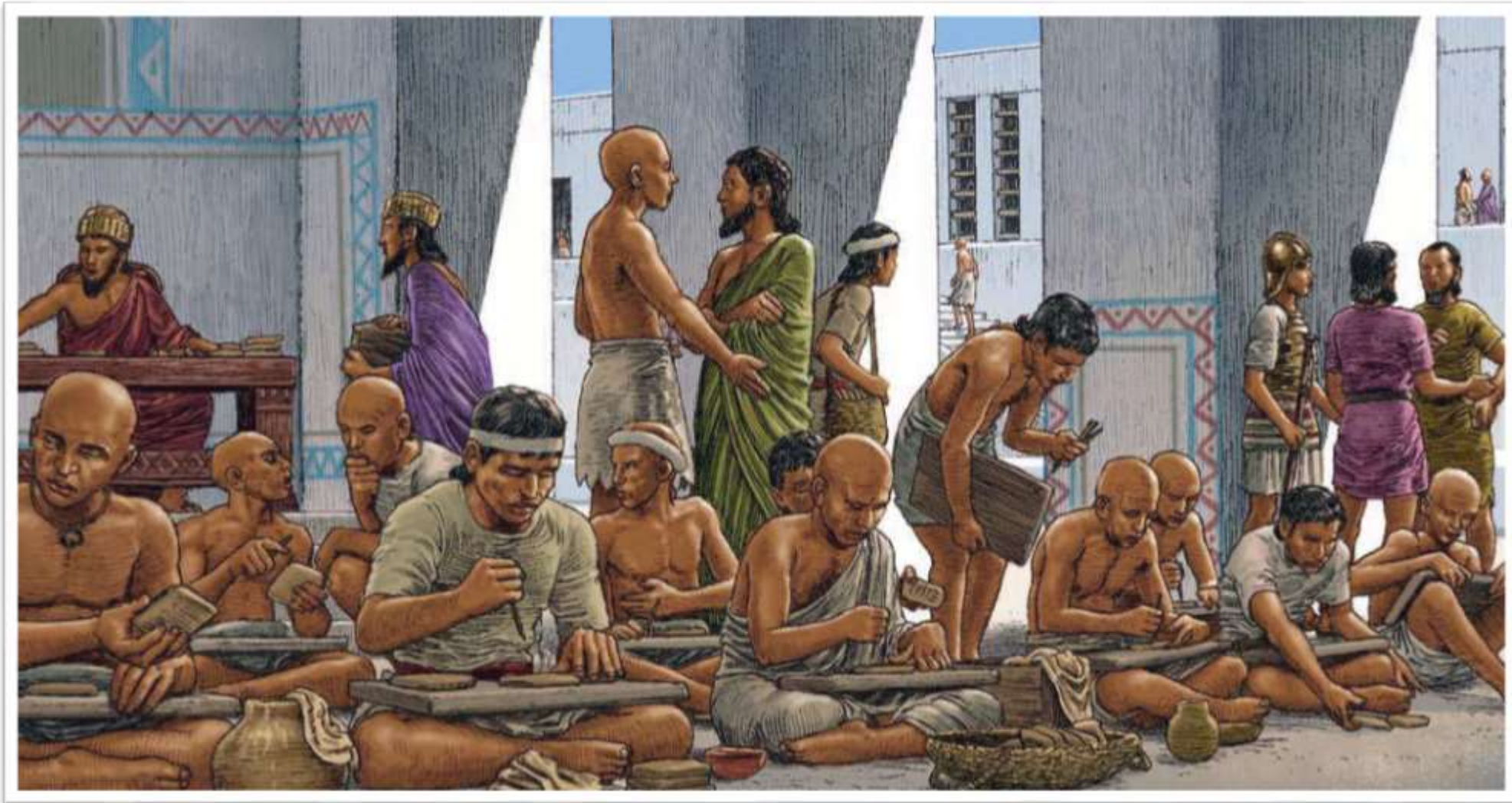

Ashur Cherry
York University
Toronto, Ontario

Copyright © 2017

All rights reserved.

No part of this publication may be reproduced or transmitted in any form or by any means, electronic or mechanical, including photocopy, recording, or any information storage and retrieval system, without permission in writing from the author.

Acknowledgement



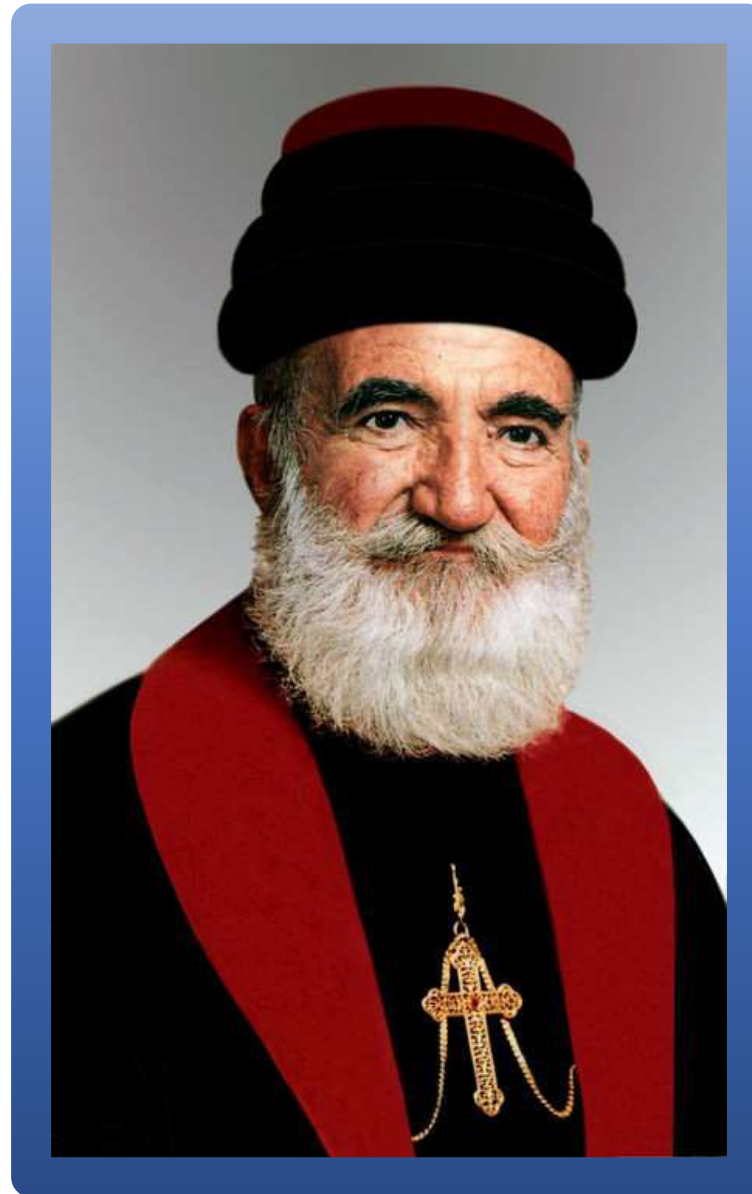
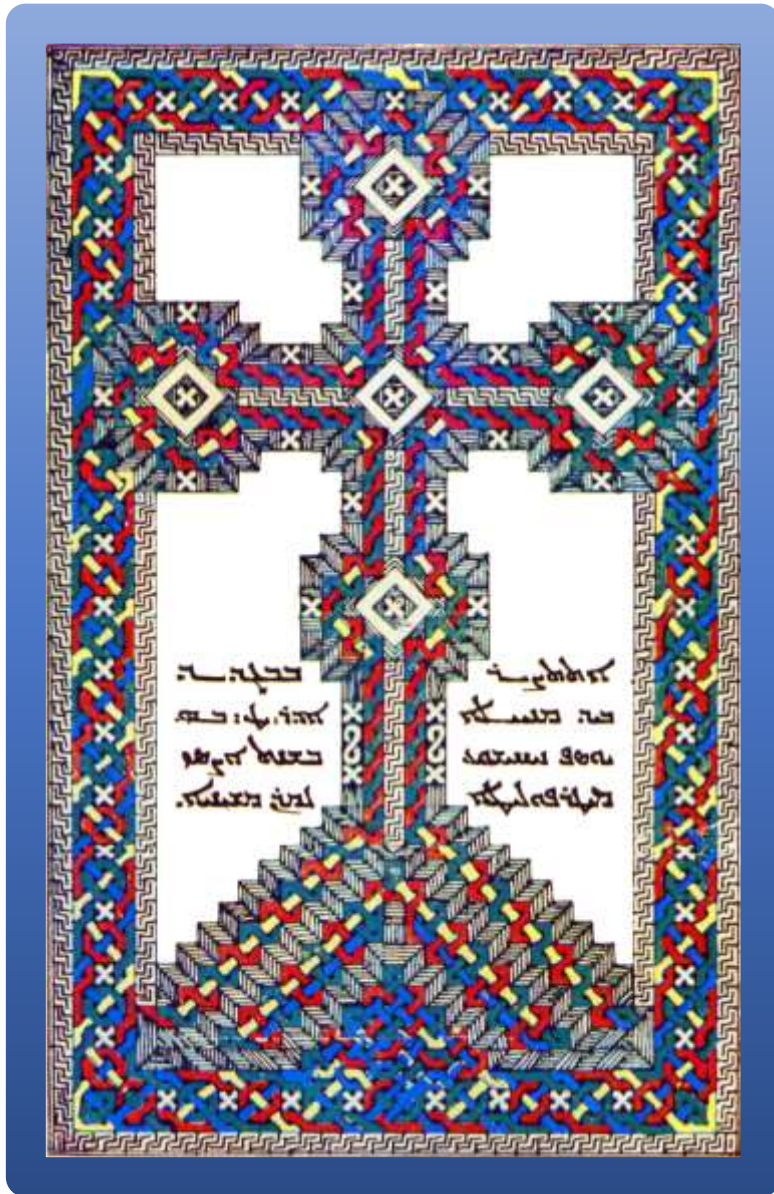

Apart from the efforts of myself, the success of any project depends largely on the encouragement of many others. I would like to show my greatest appreciation to my friends, especially late Dr. Goliath Nessian, Mr. Mirza Shmoil, Ms. Iannuzziello, Ms. Zuccarelli, Mr. Durnan, Mr. Storoschuck, Ms. Clarke, Mr. Stuart, and Miss Smith for the encouragement that I have always received from them in publishing my previous books, journal entries and developing my software. Also, I am personally would like to thank my late father, Petros Cherry, for he always supported and encouraged me while working on Assyriological projects.

**I dedicate this book in memory of His Holiness † Mar Yousip Khnanisho
Archbishop of Shamisdin and Rustaqa**



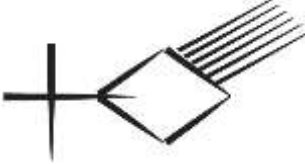

**Seventy-Two Years of Dedication Toward His People, Church and Assyrian Nation
Thursday, May 18, 1893 (Mar Ishoo, Turkey) – Sunday, July 3, 1977 (Baghdad, Iraq)**

Modifiers Overview

| Modifier | Meaning | Example |
|-------------------------|----------------|---|
| -curved | | |
| -flat | | 1-flat  |
| -gunû | extra wedges | MĂȘ-gunû  |
| -horizontally reflected | | |
| -kabatanû | slanting left | |
| -nutillû | unfinished | SAG-nutillû  |
| -šeššig | added še-sign | LAM-šeššig  |
| -tenû | slanting | LAM-tenû  |
| -variant | | |
| -vertically reflected | | TI-vertically reflected  |
| -zidatenû | slanting right | |
| -<digits>° | rotated | |

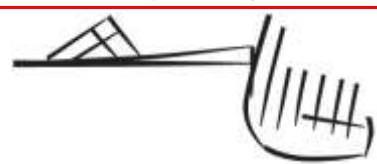
Operators Overview

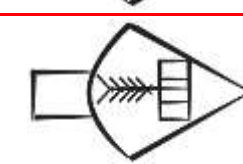
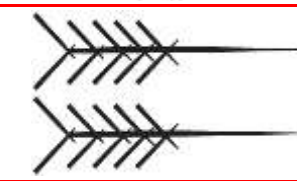

| Operator | Meaning | Example |
|----------|------------------|---|
| . | beside | APIN.APIN  |
| + | joining | ÙRI+IB  |
| × | containing | DUG×NAGA  |
| × | containing/group | DUG× (ŠE . NÁM)  |
| & | above | ŠE&ŠE  |
| % | crossing | |
| @ | opposing | |
| 3× | repeated | |
| 4× | repeated | |

Built-in Sign List Names

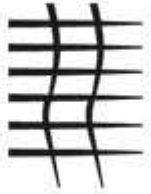

| Name | Bibliography |
|------|---|
| ABZ | R. Borger, <i>Assyrisch-babylonische Zeichenliste</i> (AOAT 33; Neukirchen-Vluyn 1978) |
| BAU | E. Burrows, <i>Archaic Texts</i> (UET 2; London 1935) |
| HZL | C. Ruster and E. Neu, <i>Hethitisches Zeichenlexikon</i> (Harrassowitz Verlag 1989) |
| KWU | N. Schneider, <i>Die Keilschriftzeichen der Wirtschaftsurkunden von Ur III</i> (Rome 1935) |
| LAK | A. Deimel, <i>Liste der archaischen Keilschriftzeichen</i> (WVDOG 40; Berlin 1922) |
| MEA | R. Labat, <i>Manuel d'épigraphie akkadienne</i> (6th ed. Paris 1988) |
| MZL | R. Borger, <i>Mesopotamisches Zeichenlexikon</i> (AOAT 305; Ugarit-Verlag 2003) |
| REC | F. Thureau-Dangin, <i>Recherches sur l'origine de l'écriture cunéiforme</i> (Paris 1898) |
| RSP | Y. Rosengarten, <i>Répertoire commenté des signes présargoniques sumériens de Lagash</i> (Paris 1967) |
| ZATU | M. Green and H. J. Nissen, <i>Zeichenliste der Archaischen Texte aus Uruk</i> (ATU 2 |

| Vowels | | | | | | | | Order | Examples | | | |
|----------------|----------------|----------------|----------------|----------------|----------------|----------------|----------------|------------------------|-----------------|-----------------|------------------|--------------------|
| A | E | I | U | a | e | i | u | first | ab | me | lim | šutul |
| Á | É | Í | Ú | á | é | í | ú | second | áb | mé | lím | šútul |
| À | È | Ì | Ù | à | è | ì | ù | third | àb | mè | lìm | šùtul |
| A ₄ | E ₄ | I ₄ | U ₄ | a ₄ | e ₄ | i ₄ | u ₄ | fourth | ab ₄ | me ₄ | lim ₄ | šutul ₄ |
| A _x | E _x | I _x | U _x | a _x | e _x | i _x | u _x | to be determined later | ab _x | me _x | lim _x | šutul _x |

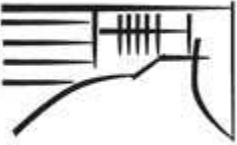
| Consonants | | Name | Phonetic Pronunciation in English |
|------------|----|-------------------------|--|
| ﺀ | ﺀ | aleph | glottal stop as 'a' in apostrophe |
| Ĝ | ĝ | ng | like sing or ring or long or young or coming |
| Ḥ | ḥ | kh | Khartoum or sheikh |
| Ṣ | ṣ | tsade or tzadi or sadhe | as deeper 's' in saw |
| Ṩ | ṩ | shin or sheen | as 'sh' in shy |
| Ṣ̈ | ṣ̈ | shin or sheen | as 'sh' in shy |
| Ṭ̇ | ṭ̇ | teth or tet | as deeper 't' in tall |

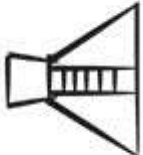
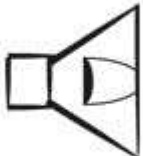

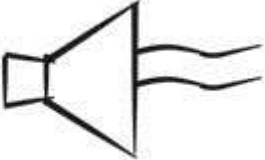
| Sign Name | Non-Numerical Sign Form |
|-----------|---|
| A |  |
| A-gunû |  |
| A-tenû |  |
| Á |  |

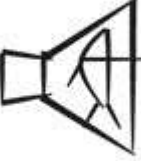
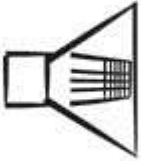
| Sign Name | Non-Numerical Sign Form |
|-----------|--|
| AB |  |
| AB-gunû |  |
| AB×1 |  |

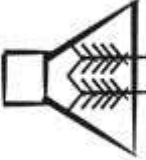
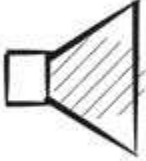
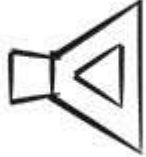
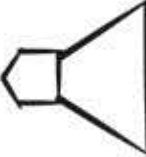

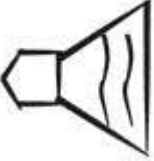
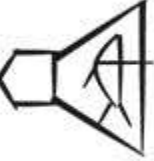
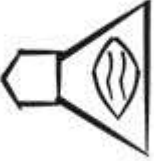
| Sign Name | Non-Numerical Sign Form |
|--------------------|---|
| AB×A-tenû |  |
| AB×ÁŠ |  |
| AB×KU ₆ |  |
| AB×SUKKAL |  |



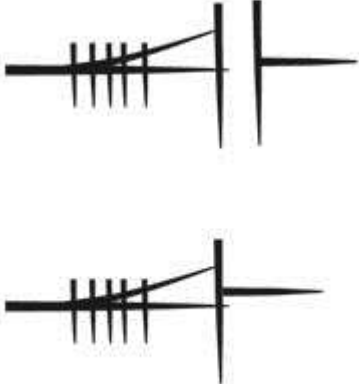
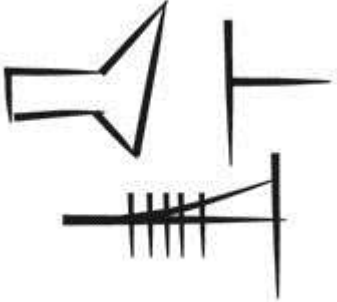
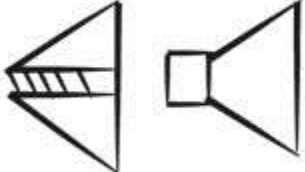

| Sign Name | Non-Numerical Sign Form |
|---------------|---|
| AB× (ŠE & ŠE) |  |
| AB× X |  |
| AB× ZATU659 |  |
| AB |  |

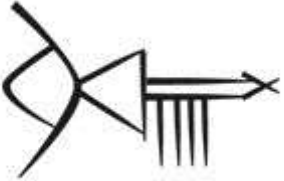

| Sign Name | Non-Numerical Sign Form |
|--------------------------------|---|
| $AB \times A$ |  |
| $AB \times KU_6$ |  |
| $AB \times \check{S}\grave{A}$ |  |

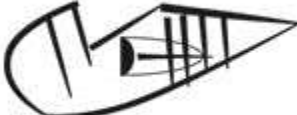
| Sign Name | Non-Numerical Sign Form |
|---|--|
| <p style="text-align: center;">ÁB</p> |  |
| <p style="text-align: center;">ÁB×2</p> |  |



| Sign Name | Non-Numerical Sign Form |
|---|---|
| <p data-bbox="612 402 819 451">ABGAL</p> |  |
| <p data-bbox="612 873 819 922">ABRIG</p> |  |
| <p data-bbox="631 1239 801 1287">ABZU</p> |  |

| Sign Name | Non-Numerical Sign Form |
|-----------|---|
| AD |  |
| AD |  |
| AD |  |
| ADAB |  |

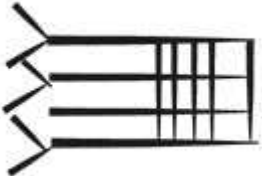
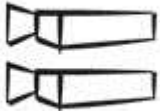
| Sign Name | Non-Numerical Sign Form |
|-----------|---|
| ADDA |  |
| ADDA-tenû |  |
| ÁGAR |  |
| AK |  |

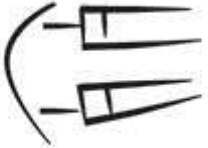
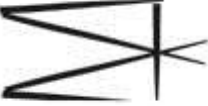
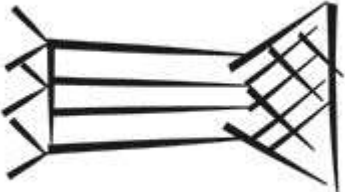
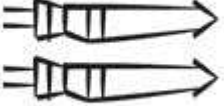
| Sign Name | Non-Numerical Sign Form |
|-----------|---|
| AK |  |
| AL |  |
| ALAN |  |
| ALAN |  |

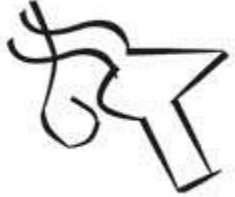

| Sign Name | Non-Numerical Sign Form |
|-----------|---|
| ALAN |  |
| ALAN |  |
| ALAN |  |
| ALAN |  |

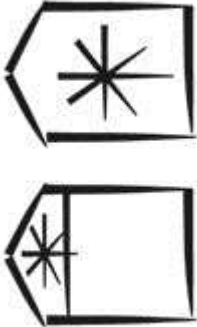
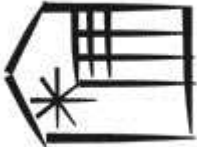
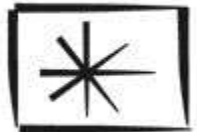

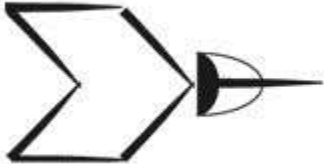
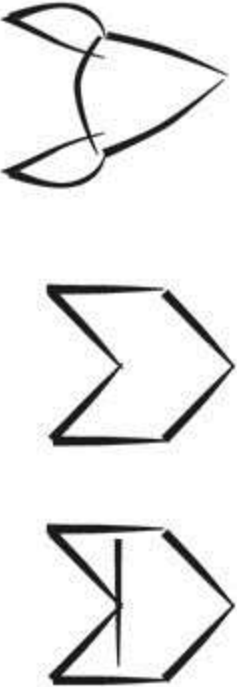
| Sign Name | Non-Numerical Sign Form |
|-----------|--|
| ALIM |  |
| AM |  |
| AM |  |

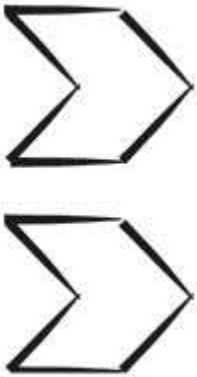
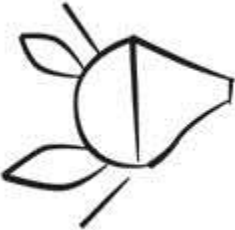

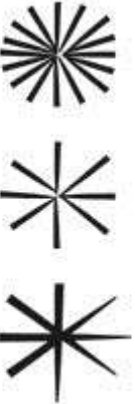
| Sign Name | Non-Numerical Sign Form |
|-----------|--|
| AMA |  |
| AMA × É |  |
| AMA |  |

| Sign Name | Non-Numerical Sign Form |
|-----------|--|
| AMAR.1 |  |
| AMAR |  |

| Sign Name | Non-Numerical Sign Form |
|-----------|---|
| AMAR-gunû |  |
| AMAR&AMAR |  |
| AMAR×TAR |  |

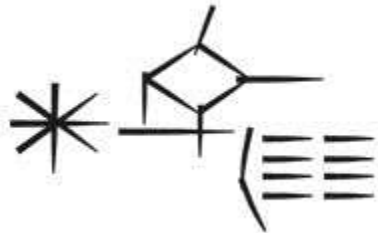

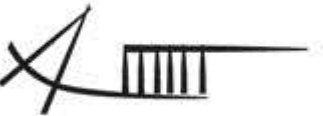

| Sign Name | Non-Numerical Sign Form |
|-----------|---|
| AN |  |
| ANŠE |  |
| ANŠE |  |

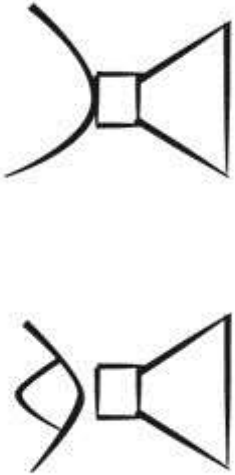

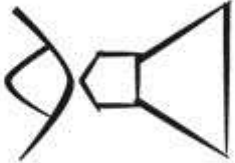
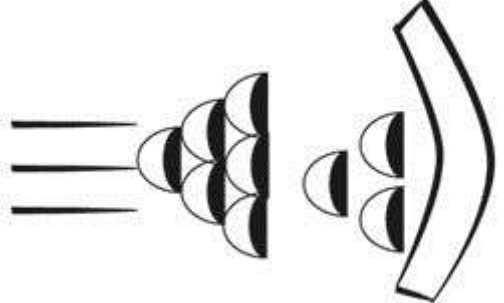
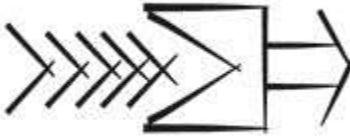

| Sign Name | Non-Numerical Sign Form |
|-----------|---|
| ANŠE |  |
| ANŠE |  |
| ÁNŽU |  |



| Sign Name | Non-Numerical Sign Form |
|-----------|---|
| APIN.APIN |  |
| APIN |  |
| APIN |  |



| Sign Name | Non-Numerical Sign Form |
|---|--|
| <p data-bbox="631 365 801 414">APIN</p> |  |
| <p data-bbox="596 873 838 928">ÁRARMA</p> |  |

| Sign Name | Non-Numerical Sign Form |
|---------------|--|
| <p>ÁRARMA</p> |  |
| <p>ARATTA</p> |  |
| <p>ÁSAL</p> |  |

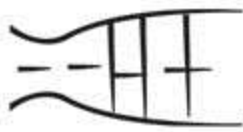

| Sign Name | Non-Numerical Sign Form |
|-----------|---|
| ASAR |  |
| ÁŠ |  |
| A×1 |  |
| A×ÁB |  |

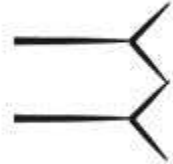
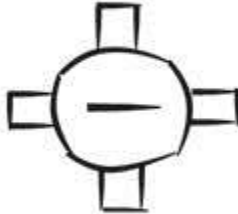
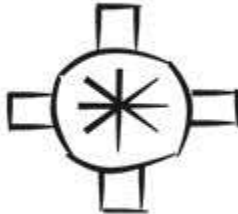

| Sign Name | Non-Numerical Sign Form |
|-----------|---|
| A×AN |  |
| A×EN |  |
| A×ŠUBUR |  |
| A×ZATU672 |  |

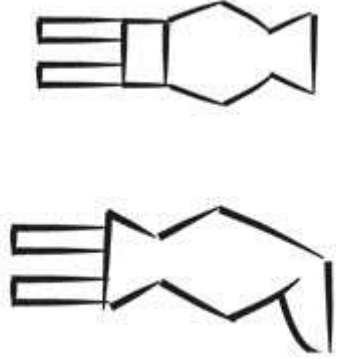
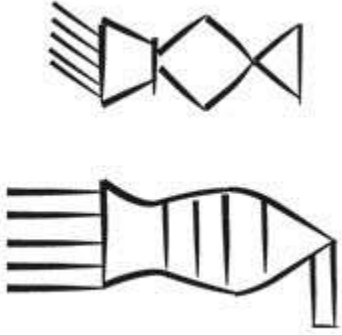
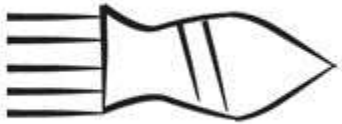

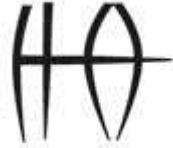
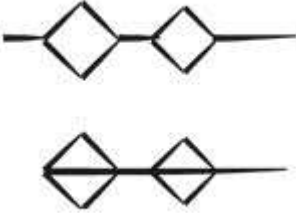
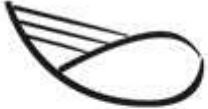
| Sign Name | Non-Numerical Sign Form |
|-----------|---|
| AZ |  |
| AZU |  |
| BA |  |
| BAD |  |

| Sign Name | Non-Numerical Sign Form |
|-----------|---|
| BAD&BAD |  |
| BÀD |  |
| BÀD |  |
| BÀD |  |

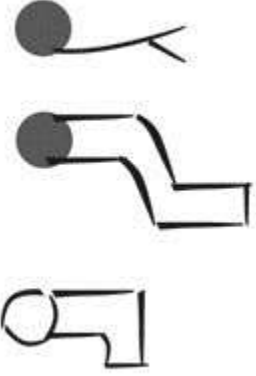

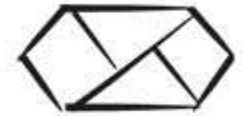
| Sign Name | Non-Numerical Sign Form |
|-----------|---|
| BÁḤAR |  |
| BÁḤAR |  |
| BÁḤAR |  |

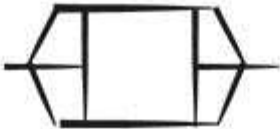
| Sign Name | Non-Numerical Sign Form |
|-----------|--|
| BALA |  |
| BALA |  |
| BALAG |   |

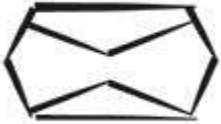

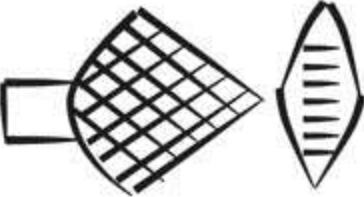
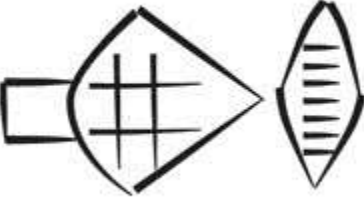
| Sign Name | Non-Numerical Sign Form |
|-----------|--|
| BAN |  |
| BAN |  |
| BANŠUR |  |

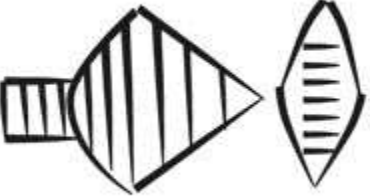
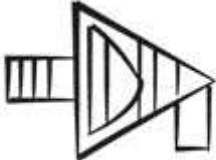
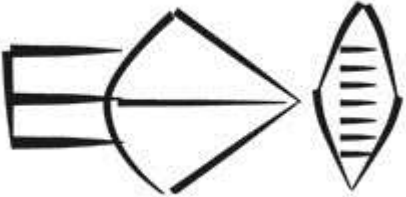

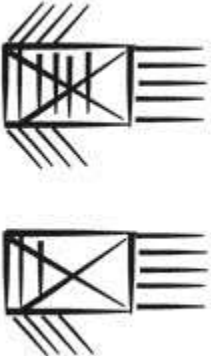
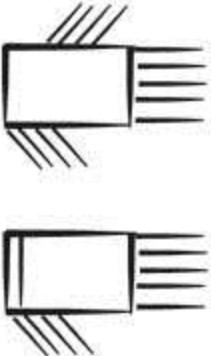
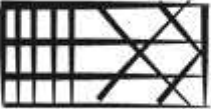

| Sign Name | Non-Numerical Sign Form |
|-------------|---|
| BANŠUR-tenû |  |
| BANŠUR |  |
| BANŠUR |  |
| BANŠUR |  |

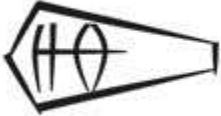

| Sign Name | Non-Numerical Sign Form |
|-----------|--|
| BAPP IR |  |
| BAPP IR |  |
| BAPP IR |  |

| Sign Name | Non-Numerical Sign Form |
|-----------|---|
| BAPPIR |  |
| BAPPIR |  |
| BAPPIR |  |
| BAR |  |



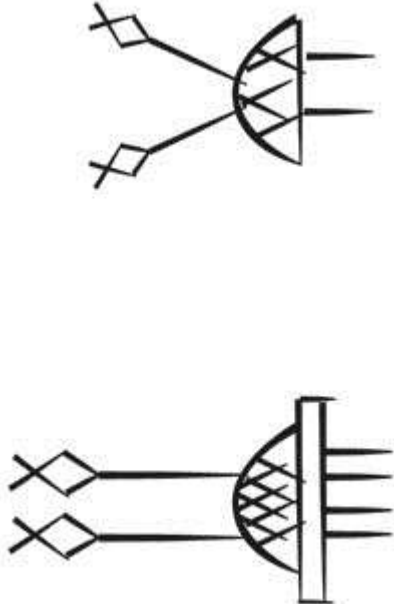

| Sign Name | Non-Numerical Sign Form |
|-----------|---|
| BÁRA |  |
| BÁRA |  |
| BÀRA |  |



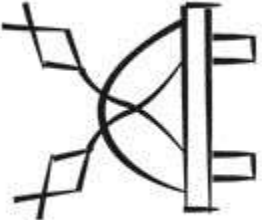
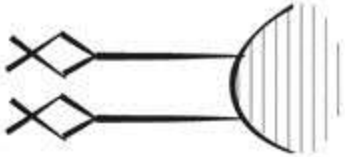
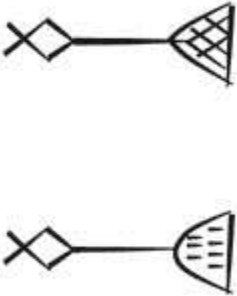

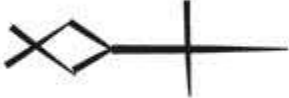
| Sign Name | Non-Numerical Sign Form |
|-----------|---|
| BIR |  |
| BIR |  |
| BIR |  |

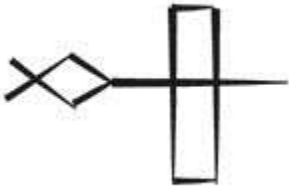



| Sign Name | Non-Numerical Sign Form |
|-----------|---|
| BÌR |   |
| BÌR |   |

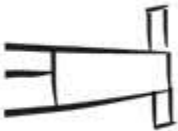



| Sign Name | Non-Numerical Sign Form |
|--------------------------------|--|
| <p>(BU&BU) .NÁ</p> |  |
| <p>(BU&BU) .NÁ-nutillû</p> |  |



| Sign Name | Non-Numerical Sign Form |
|--------------------|--|
| (BU&BU) .NÁ |  |
| (BU&BU) .X |  |
| BU+DU ₆ |  |



| Sign Name | Non-Numerical Sign Form |
|-------------|---|
| BU×1 |  |
| BU×A |  |
| BU×GIŠ-tenû |  |
| BU |  |



| Sign Name | Non-Numerical Sign Form |
|-----------|---|
| BU.NÁ |  |
| BÙ |  |
| BULUG |  |
| BÙLUG |  |

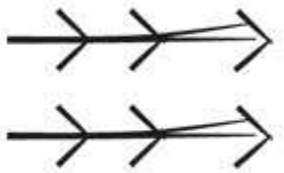

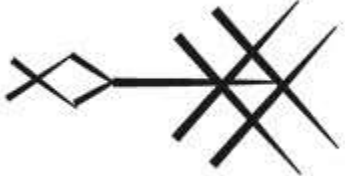
| Sign Name | Non-Numerical Sign Form |
|-----------|---|
| BUR |  |
| BUR |  |
| BUR |  |
| BUR |  |

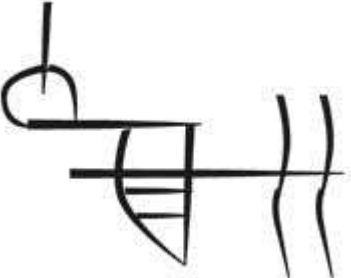

| Sign Name | Non-Numerical Sign Form |
|-----------|---|
| BÚR |  |
| DA |  |
| DA.LIŠ |  |
| DA |  |

| Sign Name | Non-Numerical Sign Form |
|-----------|--|
| DA |  |
| DA |  |
| DAG |  |
| DAḤ |  |



| Sign Name | Non-Numerical Sign Form |
|-----------|--|
| DAM |  |
| DANNA |  |
| DAR |  |

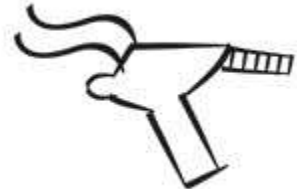

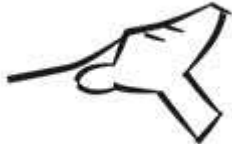
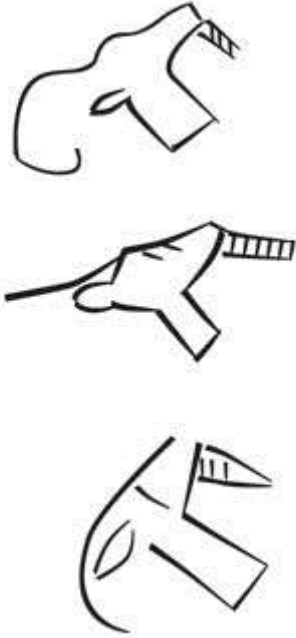

| Sign Name | Non-Numerical Sign Form |
|-----------|---|
| DAR×A |  |
| DAR |  |
| DAR |  |

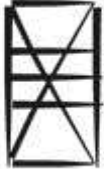
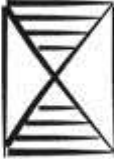



| Sign Name | Non-Numerical Sign Form |
|-----------|--|
| DAR |  |
| DÀRA |  |
| DÀRA |  |



| Sign Name | Non-Numerical Sign Form |
|-----------------|---|
| DÀRA |  |
| DÀRA×KÁR |  |
| DÀRA× (KÁR. ŠE) |  |





| Sign Name | Non-Numerical Sign Form |
|-----------|--|
| DÀRA |  |
| DÀRA×KÁR |  |



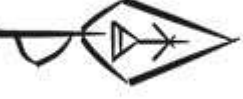

| Sign Name | Non-Numerical Sign Form |
|-------------------|---|
| DÀRA× (KÁR. ŠE) |  |
| DARA ₄ |  |
| DARA ₄ |  |
| DARA ₄ |  |



| Sign Name | Non-Numerical Sign Form |
|-------------------|---|
| DARA ₄ |  |
| DARA ₄ |  |
| DARA ₄ |  |
| DARA ₄ |  |



| Sign Name | Non-Numerical Sign Form |
|-------------------|---|
| DARA ₄ |  |
| DARA ₄ |  |
| DI |  |
| DI-tenû |  |

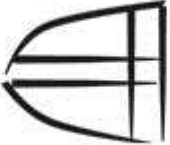

| Sign Name | Non-Numerical Sign Form |
|-----------|---|
| DILMUN |  |
| DIM |  |
| DIM×GU |  |

| Sign Name | Non-Numerical Sign Form |
|-----------|---|
| DIM×X |  |
| DIM |  |
| DIM |  |
| DIN |  |
| DIN-tenû |  |

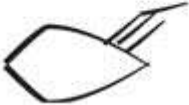
| Sign Name | Non-Numerical Sign Form |
|----------------------|--|
| DU-gunû |  |
| DU ₆ |   |
| DU ₆ ×DIŠ |  |

| Sign Name | Non-Numerical Sign Form |
|-----------------|---|
| DU ₆ |  |
| DU ₆ |  |
| DU ₇ |  |
| DU ₈ |  |

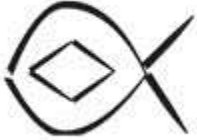
| Sign Name | Non-Numerical Sign Form |
|-----------------|--|
| DU ₈ |   |
| DU ₈ |  |

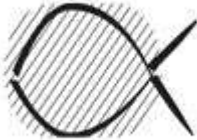
| Sign Name | Non-Numerical Sign Form |
|----------------------------|---|
| $DU_8 - \text{gun}\hat{u}$ |  |
| $DU_8 \times \text{HI}$ |  |
| $DU_8 \times \text{UDU}$ |  |
| $DU_8 \times X$ |  |

Sign Name

Non-Numerical Sign Form

DUB

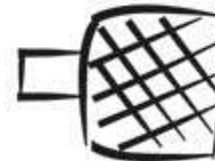
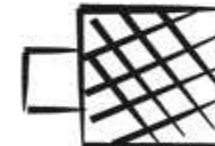
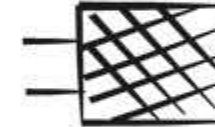
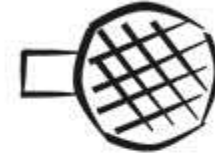
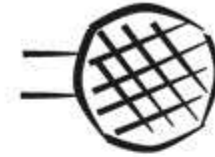

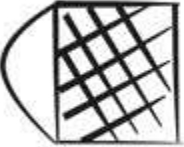
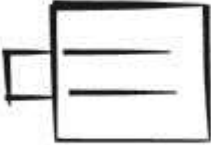
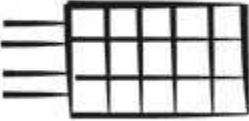
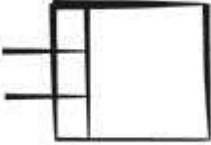
| Sign Name | Non-Numerical Sign Form |
|-----------|---|
| DUB |  |
| DUB |  |
| DUB |  |
| DUB |  |

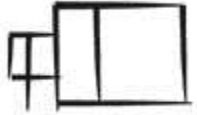
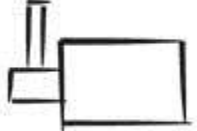
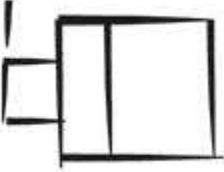
| Sign Name | Non-Numerical Sign Form |
|-----------|--|
| DÚB |  |
| DUB×DIŠ |  |
| DUB×DIŠ |  |
| DUB×DIŠ |  |

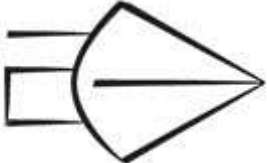
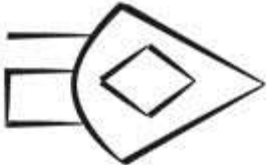
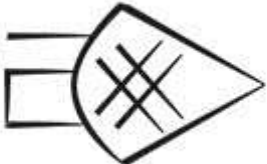
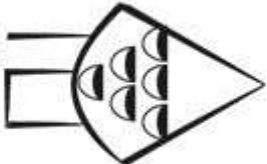
| Sign Name | Non-Numerical Sign Form |
|------------|---|
| DUG×1 |  |
| DUG×HI |  |
| DUG×KASKAL |  |
| DUG×LAM |  |

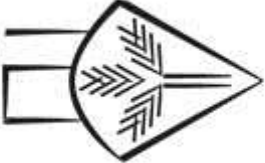
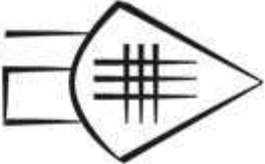
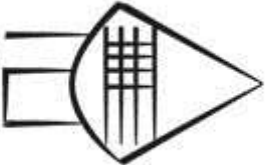
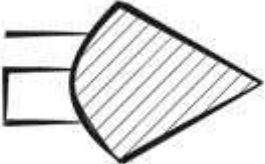
| Sign Name | Non-Numerical Sign Form |
|-----------|---|
| DUG×NAGA |  |
| DUG×Ú |  |
| DUG×Ú |  |
| DUG×X |  |

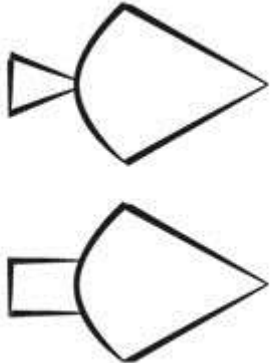
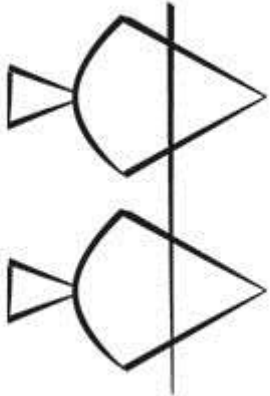
| Sign Name | Non-Numerical Sign Form |
|---------------|--|
| DUG |  |
| (DUG&DUG) × 1 |  |

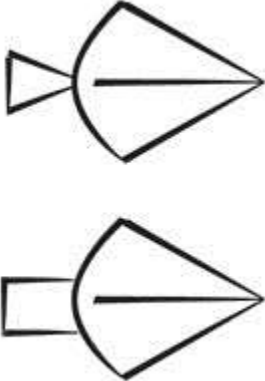
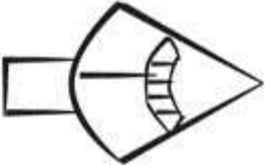
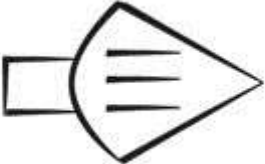

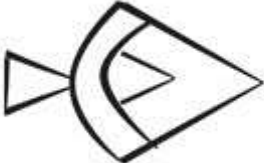
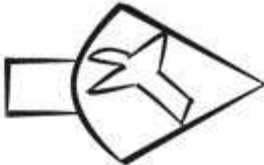
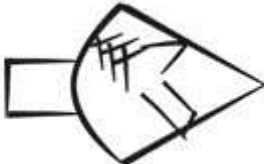
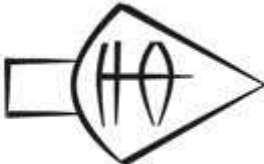
| Sign Name | Non-Numerical Sign Form |
|---------------|---|
| DUG×1 |  |
| DUG× (1 . KÙ) |  |
| DUG×3 |  |

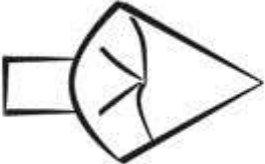
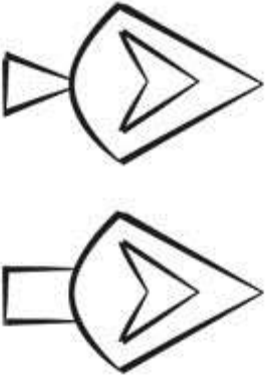
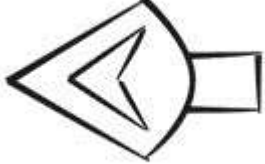
| Sign Name | Non-Numerical Sign Form |
|-----------|---|
| DUG×ÁB |  |
| DUG×ANŠE |  |
| DUG×ANŠE |  |
| DUG×BALA |  |

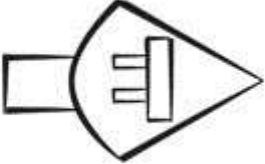
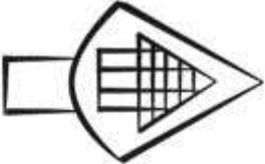
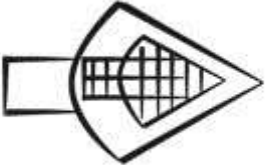
| Sign Name | Non-Numerical Sign Form |
|---------------------------------|---|
| DUG×BÌR |  |
| DUG×DIN |  |
| (DUG×DIN) -vertically reflected |  |

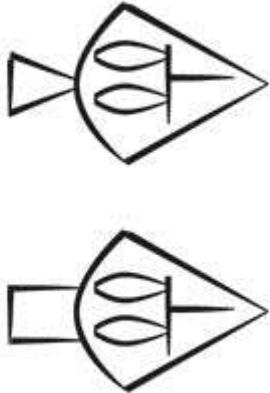
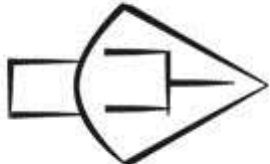
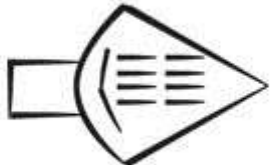
| Sign Name | Non-Numerical Sign Form |
|-----------|---|
| DUG×E |  |
| DUG×GA |  |
| DUG×GA |  |

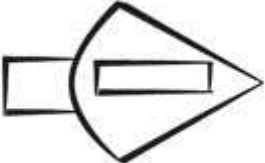
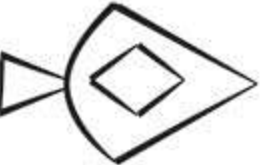
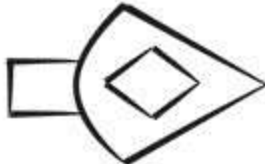
| Sign Name | Non-Numerical Sign Form |
|---------------------|---|
| DUG×GEŠTU |  |
| DUG×GEŠTU |  |
| DUG×GI ₆ |  |

| Sign Name | Non-Numerical Sign Form |
|-------------|--|
| DUG×GIŠ |  |
| DUG×ĦI |   |
| DUG×ĦI-gunû |  |

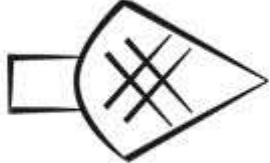
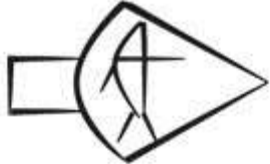
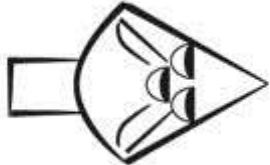
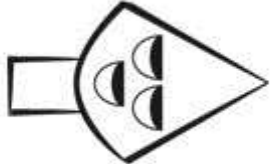
| Sign Name | Non-Numerical Sign Form |
|---------------------|---|
| DUG×KASKAL |  |
| DUG×KU ₆ |  |
| DUG×KUR-gunû |  |
| DUG×KUR |  |

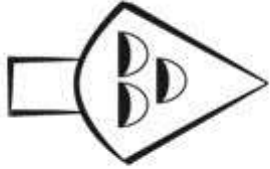
| Sign Name | Non-Numerical Sign Form |
|--------------|---|
| DUG× (KUR.X) |  |
| DUG×KUR |  |
| DUG×LAM |  |

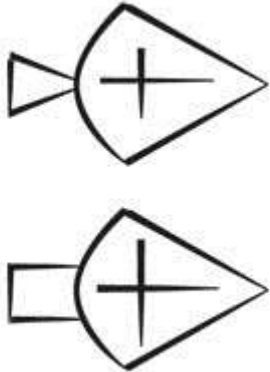
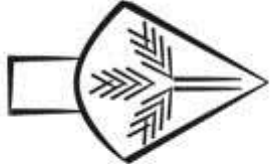
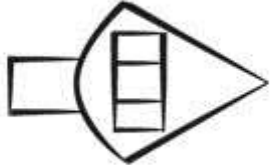
| Sign Name | Non-Numerical Sign Form |
|-----------|---|
| DUG×MAŠ |  |
| DUG×NAGA |  |
| DUG×NÁM |  |

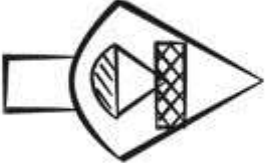
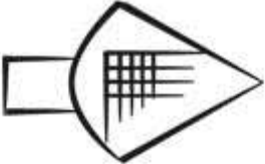
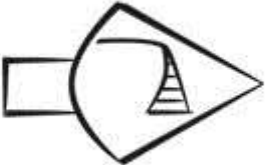
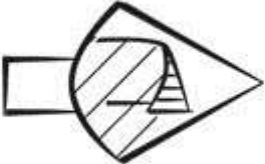
| Sign Name | Non-Numerical Sign Form |
|---------------------------|---|
| DUG× (NI-gunû .ZATU779) |  |
| DUG× SA |  |
| DUG× SI ₄ |  |
| DUG× (SI ₄ .X) |  |

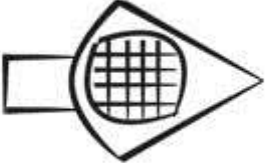
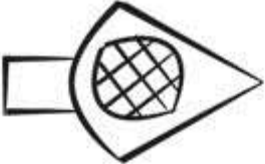
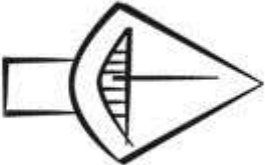
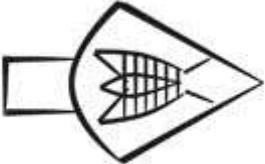
| Sign Name | Non-Numerical Sign Form |
|----------------------|---|
| DUG×SÍG |  |
| DUG×SÍG |  |
| DUG×SIG ₇ |  |
| DUG×SUĞUR |  |

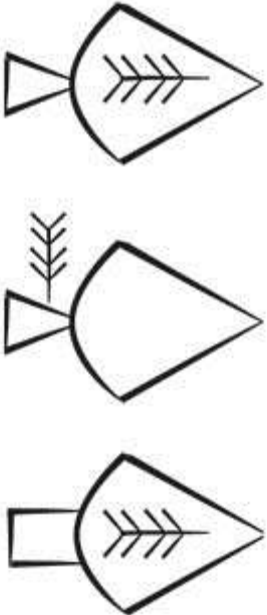
| Sign Name | Non-Numerical Sign Form |
|-----------|--|
| DUG×ŠÁḤ |  |
| DUG×ŠĚ |  |

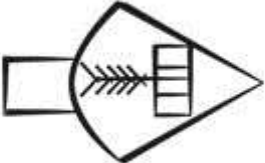
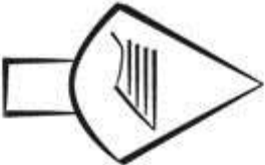
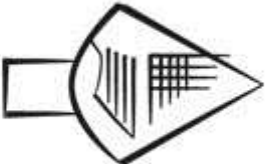
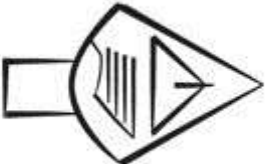
| Sign Name | Non-Numerical Sign Form |
|-------------------------------|---|
| DUG× (ŠE . NÁM) |  |
| DUG× TAK ₄ |  |
| DUG× (TAK ₄ . SA) |  |
| DUG× (TAK ₄ . SAL) |  |

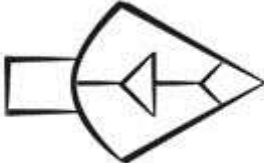
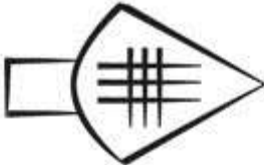
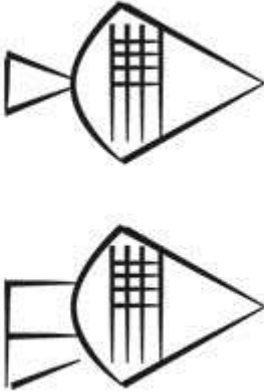

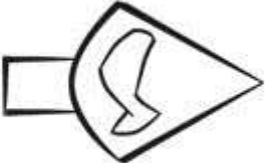
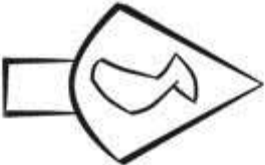
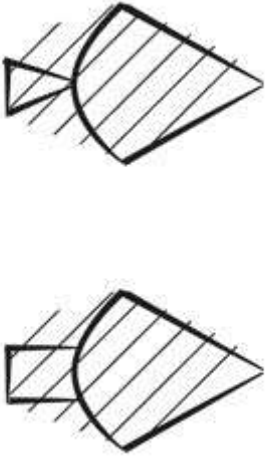
| Sign Name | Non-Numerical Sign Form |
|-----------|--|
| DUG×TI |  |
| DUG×Ú |  |
| DUG×Ú |  |

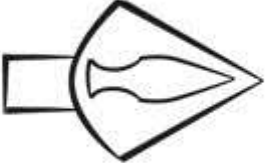
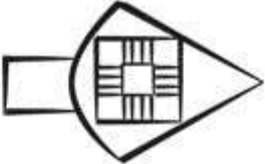
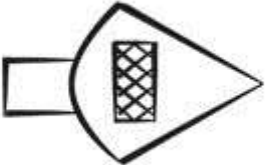
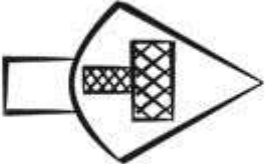

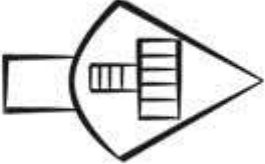
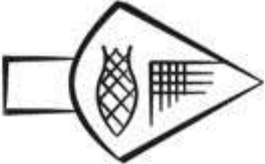
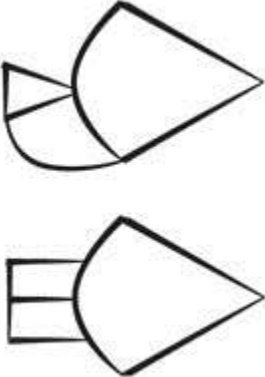
| Sign Name | Non-Numerical Sign Form |
|-------------|--|
| DUG×ÙĤ |  |
| DUG×ÙĤ-tenû |  |
| DUG×X |  |

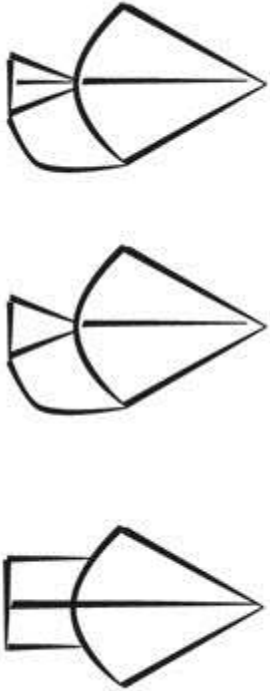

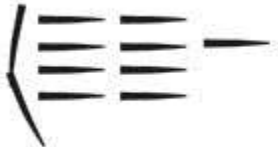
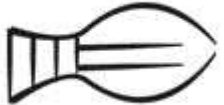

| Sign Name | Non-Numerical Sign Form |
|-------------|---|
| DUG×ZATU707 |  |
| DUG×ZATU764 |  |
| DUG×ZATU779 |  |
| DUG×ZATU780 |  |



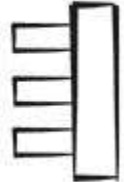

| Sign Name | Non-Numerical Sign Form |
|------------------|--|
| DUG×ZATU781 |  |
| DUG×(ZATU789.SA) |  |
| DUG |  |

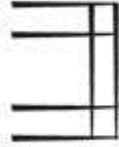
| Sign Name | Non-Numerical Sign Form |
|-----------|--|
| DUG-tenû |  |
| DUG×1 |  |

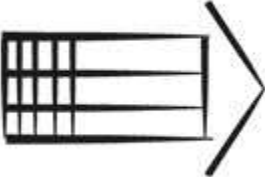

| Sign Name | Non-Numerical Sign Form |
|-----------|---|
| DUG |  |
| DUGUD |  |
| DUR |  |
| DUR |  |

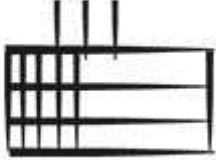
| Sign Name | Non-Numerical Sign Form |
|-----------|---|
| DÚR |  |
| DU×DIŠ |  |
| E |  |
| E |  |

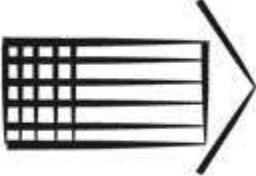
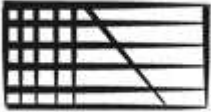
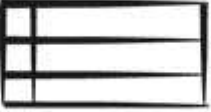
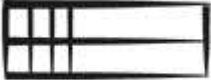

| Sign Name | Non-Numerical Sign Form |
|-----------|---|
| E |  |
| E |  |
| E |  |
| É |  |

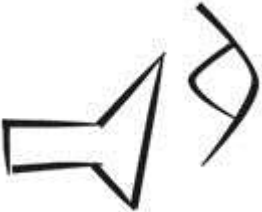

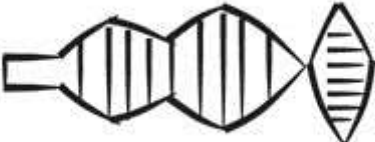
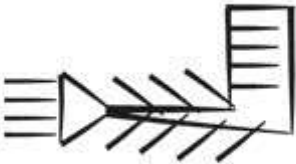
| Sign Name | Non-Numerical Sign Form |
|-----------|---|
| É.LIŠ |  |
| É×1-tenû |  |
| É×3 |  |
| É |  |

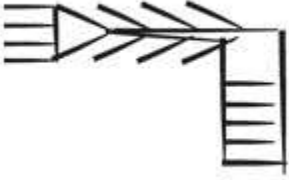
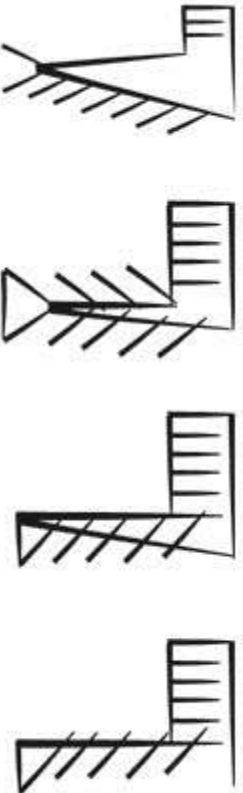

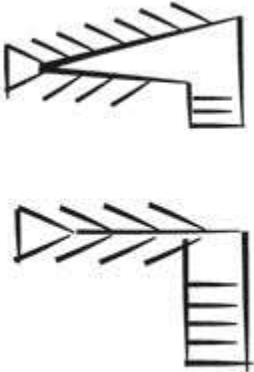
| Sign Name | Non-Numerical Sign Form |
|-----------|---|
| É.LIŠ |  |
| É×1-tenû |  |
| É |  |
| É |  |

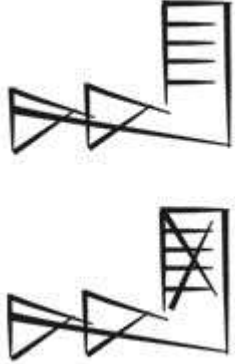
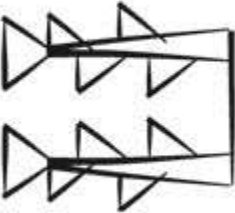

| Sign Name | Non-Numerical Sign Form |
|-----------|---|
| È |  |
| È |  |
| EDIN |  |
| EN-gunû |  |

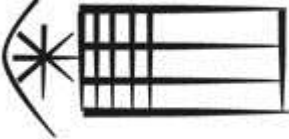
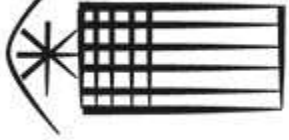

| Sign Name | Non-Numerical Sign Form |
|-----------|--|
| EN-gunû |  |
| EN |  |

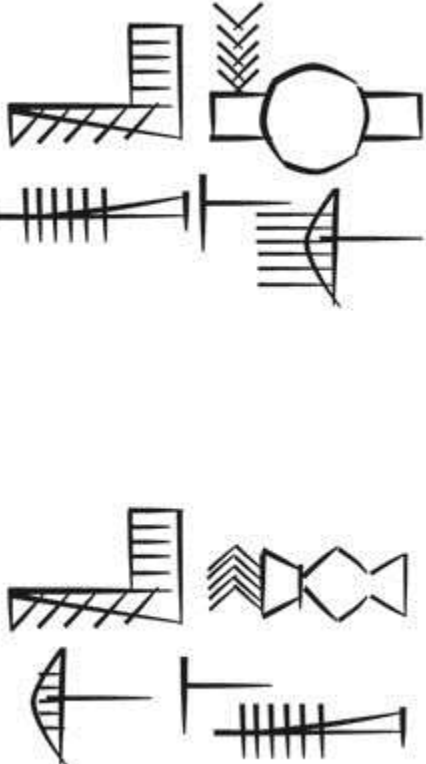

| Sign Name | Non-Numerical Sign Form |
|-----------|---|
| EN |  |
| EN-tenû |  |

| Sign Name | Non-Numerical Sign Form |
|-----------|---|
| EN |  |
| EN&EN |  |
| EN |  |

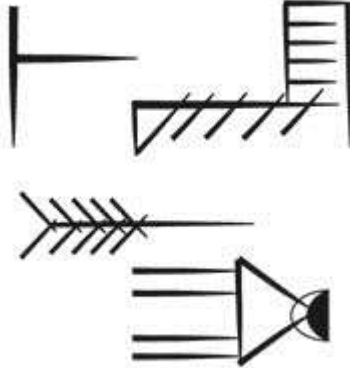
| Sign Name | Non-Numerical Sign Form |
|-----------|---|
| ÉN.É |  |
| ÉN.É |  |
| ÉN |  |
| ENDIB |  |

| Sign Name | Non-Numerical Sign Form |
|--|---|
| <p data-bbox="612 587 822 636">ENKUM</p> |  |
| <p data-bbox="612 1166 822 1214">ENLIL</p> |  |

| Sign Name | Non-Numerical Sign Form |
|-----------|--|
| ENSI |  |
| ÉNSI |  |
| ERIM |  |

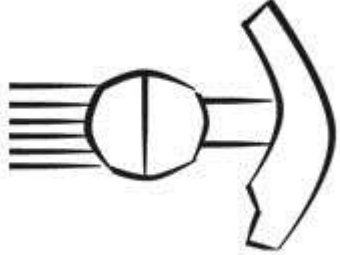
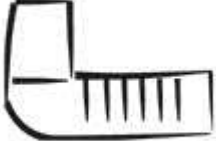
| Sign Name | Non-Numerical Sign Form |
|-----------|---|
| ERIM |  |
| ERIM |  |
| ÉRIM |  |
| ERIN |  |

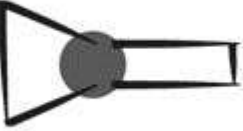
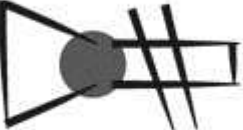
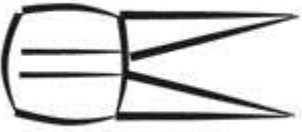

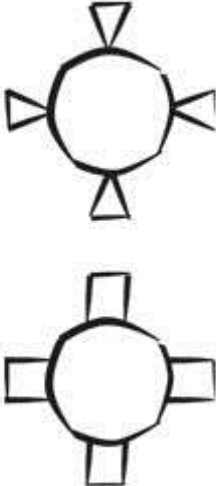
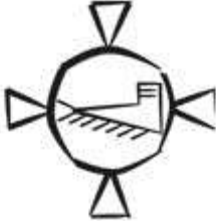
| Sign Name | Non-Numerical Sign Form |
|-----------|---|
| EŠDA |  |
| EŠDA×TAR |  |
| EŠGAR |  |

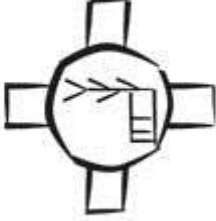
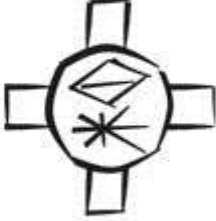
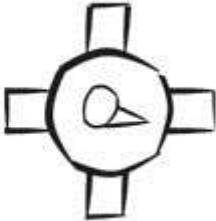
| Sign Name | Non-Numerical Sign Form |
|-----------|--|
| EZEN |  |
| EZEN×EN |  |

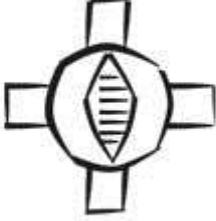
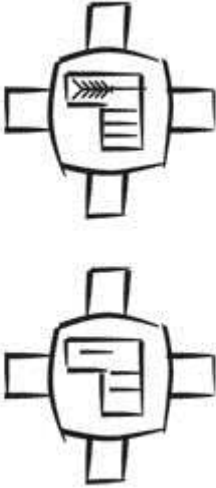
| Sign Name | Non-Numerical Sign Form |
|---------------------|--|
| EZEN×EN |  |
| EZEN× (HI . 1 . AN) |  |
| EZEN×KAB |  |

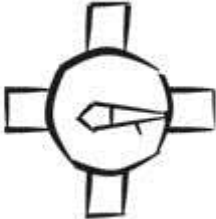
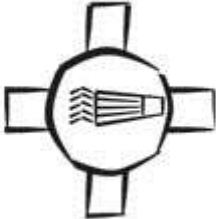
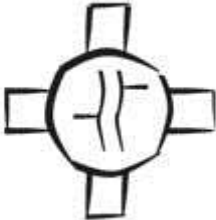

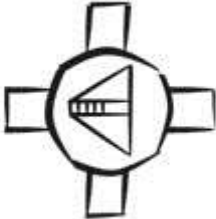
| Sign Name | Non-Numerical Sign Form |
|-----------|--|
| EZEN×KI |  |
| EZEN×LA |  |

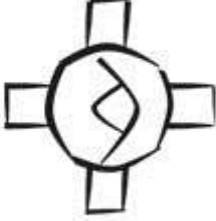
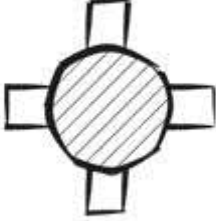
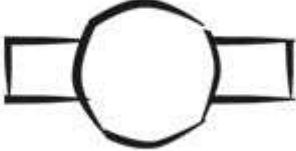

| Sign Name | Non-Numerical Sign Form |
|-------------|--|
| EZEN×NIM |  |
| EZEN×NIMGIR |  |
| EZEN×RAD |  |

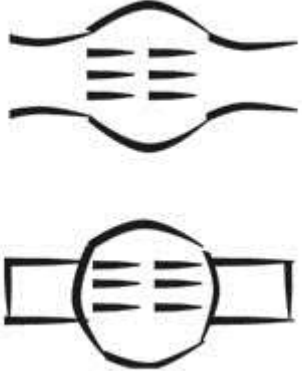

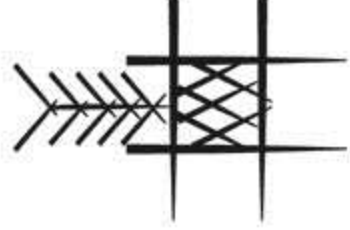
| Sign Name | Non-Numerical Sign Form |
|-------------|--|
| EZEN×SAG |  |
| EZEN×SU |  |
| EZEN× (Ú.A) |  |

| Sign Name | Non-Numerical Sign Form |
|---------------------|--|
| EZEN×U ₄ |  |
| EZEN×X |  |
| EZEN |  |

| Sign Name | Non-Numerical Sign Form |
|-----------|--|
| EZEN-tenû |  |
| EZEN×6 |  |

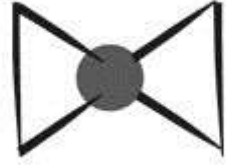
| Sign Name | Non-Numerical Sign Form |
|-----------|---|
| EZEN |  |
| EZINU |  |
| EZINU |  |

| Sign Name | Non-Numerical Sign Form |
|--------------------|--|
| EZINU |  |
| EZINU |  |
| GA ³ AR |  |

| Sign Name | Non-Numerical Sign Form |
|--------------------|--|
| GA ^ɔ AR |  |
| GA ^ɔ AR |  |
| GA ^ɔ AR |  |

Sign Name



Non-Numerical Sign Form

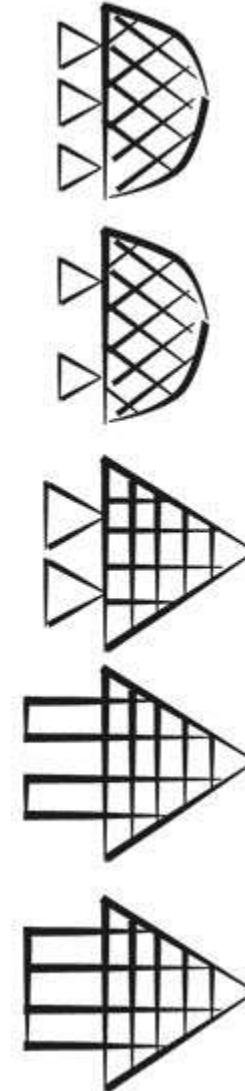

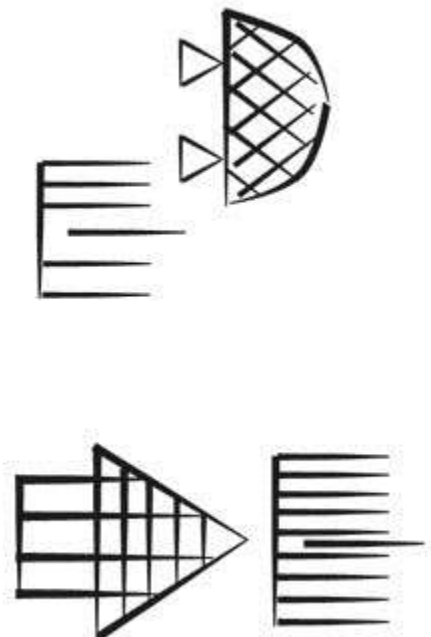

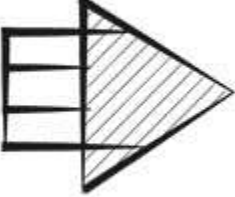
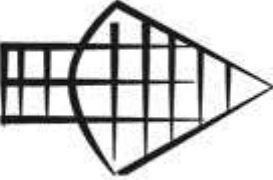
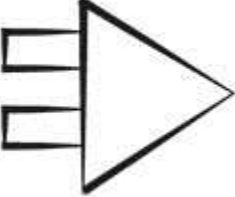
GA

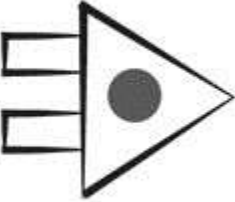
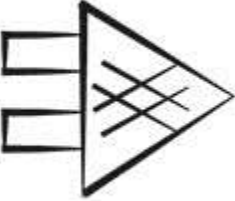

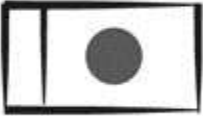



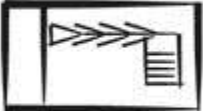

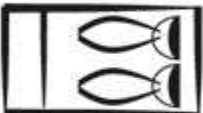

| Sign Name | Non-Numerical Sign Form |
|------------|---|
| GA.ZATU753 |  |



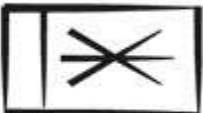

| Sign Name | Non-Numerical Sign Form |
|-----------|--|
| GA×X |  |
| GA |  |
| GA |  |

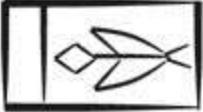
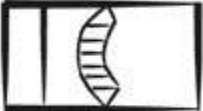

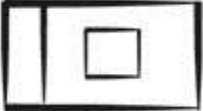

| Sign Name | Non-Numerical Sign Form |
|-----------|---|
| GA×1 |  |
| GA×KASKAL |  |
| GÁ |  |
| GÁ×1 |  |

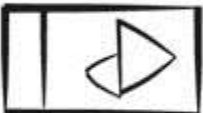

| Sign Name | Non-Numerical Sign Form |
|-----------|---|
| GÁ×1 |  |
| GÁ×A |  |
| GÁ×EN |  |
| GÁ×GEŠTU |  |
| GÁ×GEŠTU |  |

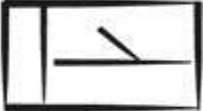

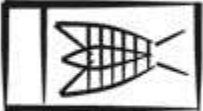

| Sign Name | Non-Numerical Sign Form |
|------------------------------|---|
| GÁ×GIR |  |
| GÁ× (GIR . KU ₆) |  |
| GÁ×GIŠ-tenû |  |
| GÁ×GU ₄ |  |
| GÁ×ḪAL |  |

| Sign Name | Non-Numerical Sign Form |
|--|---|
| GÁ×ḤI |  |
| GÁ× (ḤI . SUḤUR) |  |
| GÁ×KÙ |  |
| GÁ×KU ₆ |  |
| GÁ× (KU ₆ . KU ₆) |  |

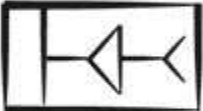
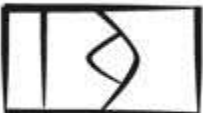



| Sign Name | Non-Numerical Sign Form |
|-----------|---|
| GÁ×LAGAB |  |
| GÁ×MAŠ |  |
| GÁ×NAGA |  |
| GÁ×NUN |  |
| GÁ×PAD |  |

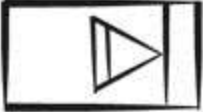
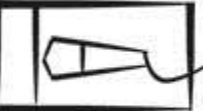
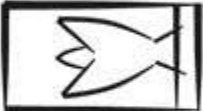
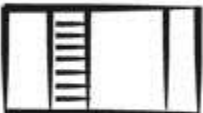

| Sign Name | Non-Numerical Sign Form |
|-------------------|---|
| GÁ×PAP |  |
| GÁ×SU |  |
| GÁ×SUḤUR |  |
| GÁ×SUKUD |  |
| GÁ× (SUKUD&SUKUD) |  |

| Sign Name | Non-Numerical Sign Form |
|--------------------|---|
| GÁ× (SUKUD&SUKUD) |  |
| GÁ× SUMAŠ |  |
| GÁ× ŠA |  |
| GÁ× TI |  |
| GÁ× U ₄ |  |

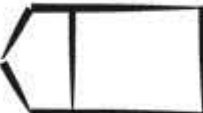

| Sign Name | Non-Numerical Sign Form |
|----------------------------|---|
| GÁ×X |  |
| GÁ |  |
| GÁ×3 |  |
| GÁ×GU ₄ |  |
| GÁ× (GU ₄ . ŠÈ) |  |

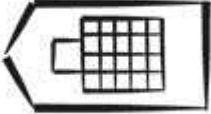
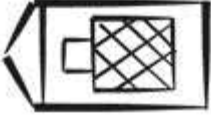
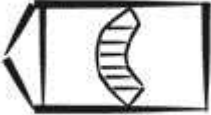
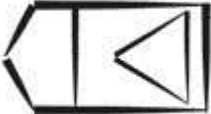
| Sign Name | Non-Numerical Sign Form |
|-----------|---|
| GÁ×NI |  |
| GÁ×NI |  |
| GÁ×NIM |  |
| GÁ×SUḤUR |  |
| GÁ×ŠÈ |  |

| Sign Name | Non-Numerical Sign Form |
|-----------|---|
| GÁ×X |  |
| GÁ |  |
| GÁ×X |  |
| GÁ |  |
| GÁ |  |

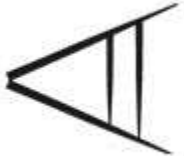
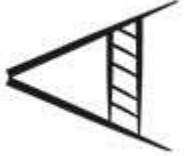
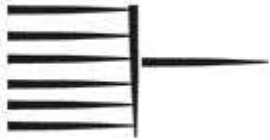
| Sign Name | Non-Numerical Sign Form |
|------------|---|
| GÁ×DUB |  |
| GÁ×DUB |  |
| GÁ×KÙ |  |
| GÁ×ZATU659 |  |
| GÁ |  |

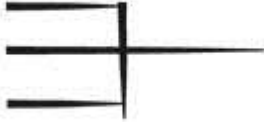
| Sign Name | Non-Numerical Sign Form |
|-----------|---|
| GADA |  |
| GADA |  |
| GADA-gunû |  |
| GAL |  |

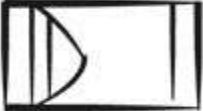
| Sign Name | Non-Numerical Sign Form |
|-----------|---|
| GAL |  |
| GALGA |  |
| GALGA |  |

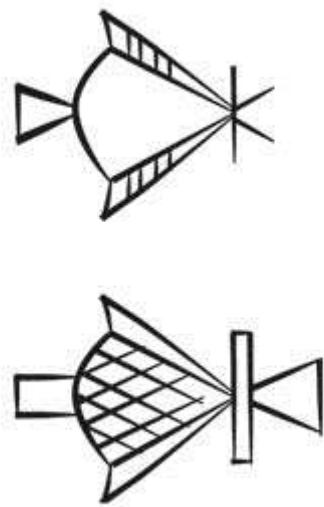
| Sign Name | Non-Numerical Sign Form |
|-----------|---|
| GAN |  |

Sign Name

Non-Numerical Sign Form

GAN

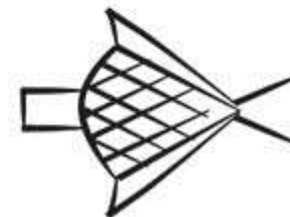
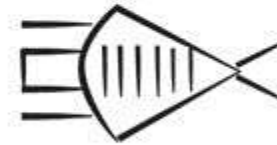
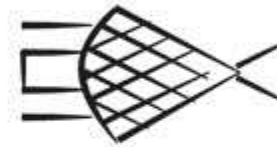
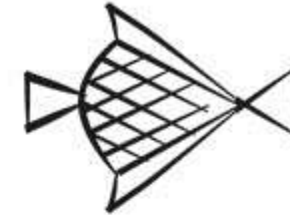

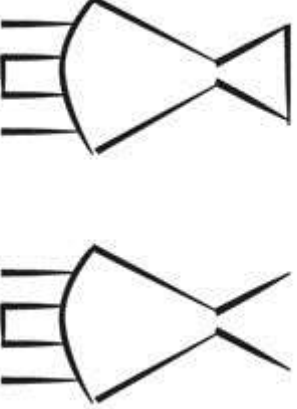
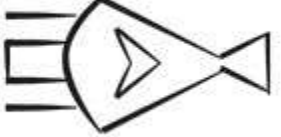
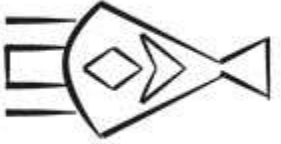

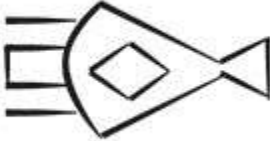
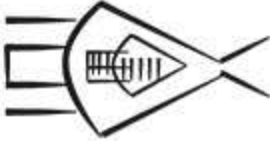
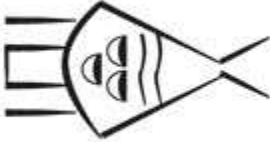
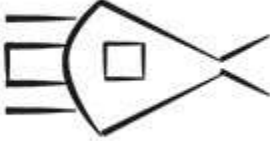

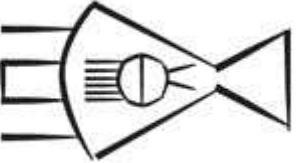
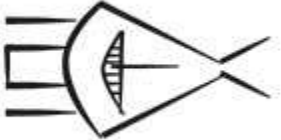
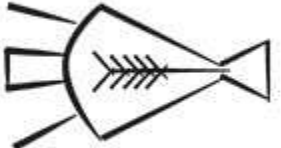
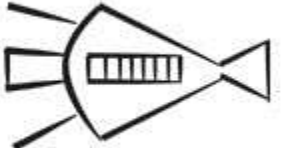

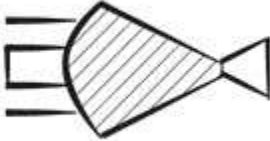
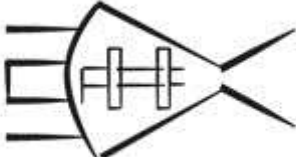
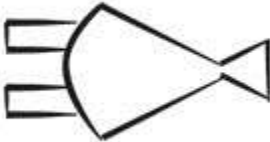
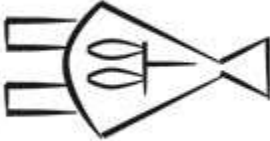
| Sign Name | Non-Numerical Sign Form |
|------------------|---|
| GAN |  |
| GAN×DIN |  |
| GAN× (ḤI . DIN) |  |

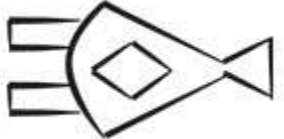
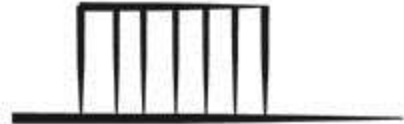

| Sign Name | Non-Numerical Sign Form |
|--------------|---|
| GAN×ḪI |  |
| GAN×KAŠ |  |
| GAN× (KUR.A) |  |
| GAN×LAGAB |  |

| Sign Name | Non-Numerical Sign Form |
|----------------------|---|
| GAN×NE |  |
| GAN×SIG ₇ |  |
| GAN×ŠE |  |
| GAN×ŠÈ-tenû |  |

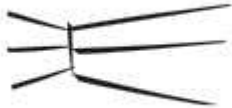

| Sign Name | Non-Numerical Sign Form |
|-------------|---|
| GAN×X |  |
| GAN×ZATU777 |  |
| GAN |  |
| GAN×GEŠTU |  |

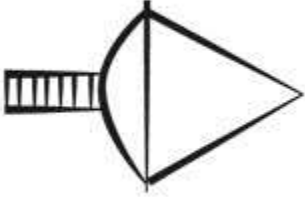

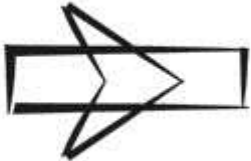
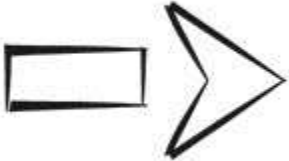
| Sign Name | Non-Numerical Sign Form |
|-----------|---|
| GAN×HỊ |  |
| GÁN |  |
| GAR |  |
| GAR-gunû |  |

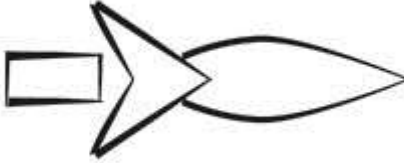
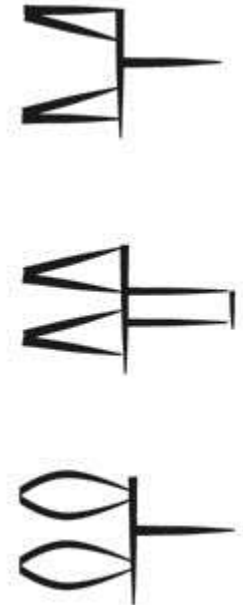

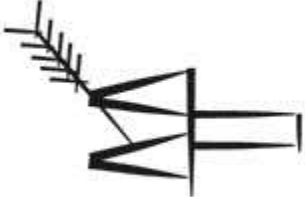
| Sign Name | Non-Numerical Sign Form |
|-----------|---|
| GAR-gunû |  |
| GAR-gunû |  |
| GÀR |  |
| GÁRA |  |

| Sign Name | Non-Numerical Sign Form |
|-----------|---|
| GÁRA |  |
| GAZI |  |
| GEŠTIN |  |
| GEŠTIN |  |

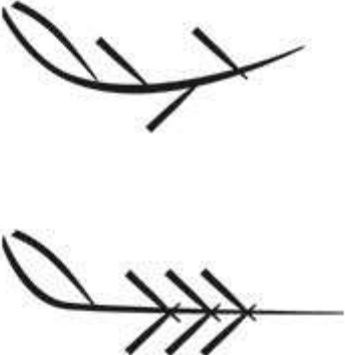
| Sign Name | Non-Numerical Sign Form |
|-----------|--|
| GEŠTIN×X |  |
| GEŠTU |  |

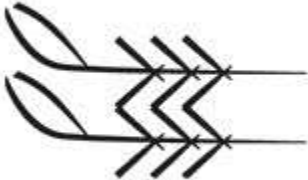

| Sign Name | Non-Numerical Sign Form |
|---------------|--|
| GEŠTU×ŠE-tenû |  |
| GEŠTU |  |
| GEŠTU |  |

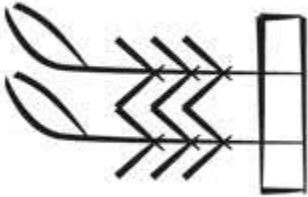
| Sign Name | Non-Numerical Sign Form |
|-----------|--|
| GEŠTU |  |
| GI |  |
| GI-tenû |  |

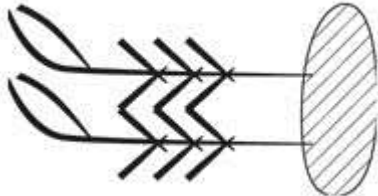
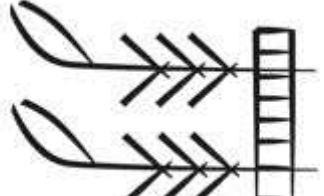
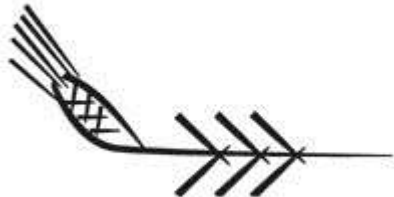

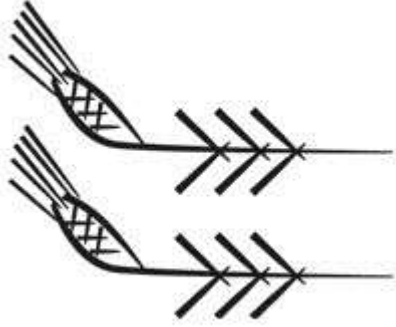
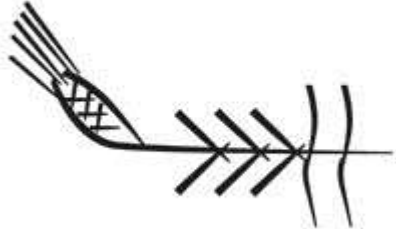
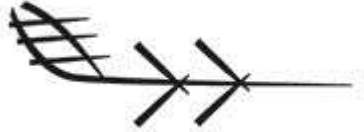
| Sign Name | Non-Numerical Sign Form |
|-------------------|--|
| GI&GI |  |
| GI&GI&GI |  |
| (GI&GI) ×GIŠ-tenû |  |

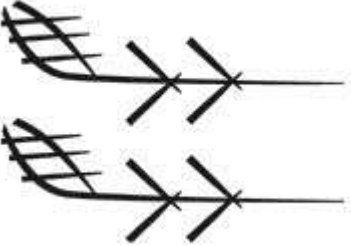

| Sign Name | Non-Numerical Sign Form |
|-----------------|--|
| (GI&GI) × X |  |
| (GI&GI) × ŠÈ |  |
| GI ₄ |  |

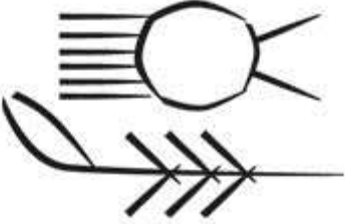
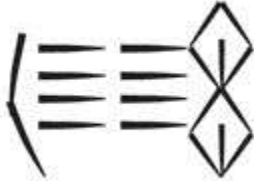

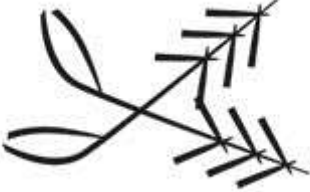
| Sign Name | Non-Numerical Sign Form |
|-----------------|---|
| $GI_4 \& GI_4$ |  |
| $GI_4 \times A$ |  |
| GI_4 |  |





| Sign Name | Non-Numerical Sign Form |
|----------------------------------|---|
| GI ₄ &GI ₄ |  |
| GI ₆ |  |
| GIBIL |  |



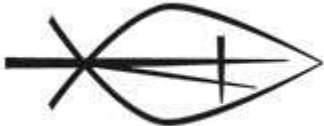
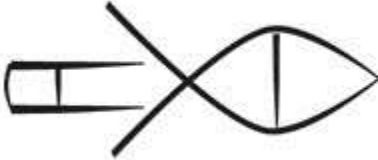

| Sign Name | Non-Numerical Sign Form |
|--------------------|---|
| GIBIL-tenû |  |
| GIBIL ₆ |  |
| GIG |  |





| Sign Name | Non-Numerical Sign Form |
|---------------------|--|
| GIL |  |
| GIR |  |
| GIR.KU ₆ |  |

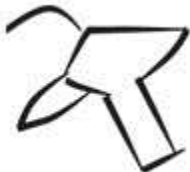

| Sign Name | Non-Numerical Sign Form |
|-----------|--|
| GIR.GIR |  |
| GIR |  |

| Sign Name | Non-Numerical Sign Form |
|-----------|---|
| GIR |  |
| GIR |  |
| GÍR |  |
| GÍR |  |

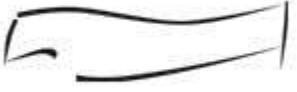
| Sign Name | Non-Numerical Sign Form |
|-----------|---|
| GÌR-gunû |  |
| GÌR-gunû |  |
| GÌR-gunû |  |
| GÌR |  |

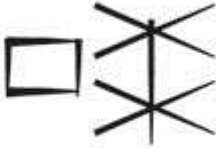
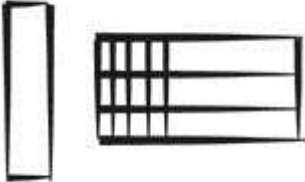

| Sign Name | Non-Numerical Sign Form |
|-----------|---|
| GÌR×ŠE |  |
| GÌR |  |
| GÌR |  |
| GÌR×KÁR |  |

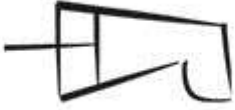
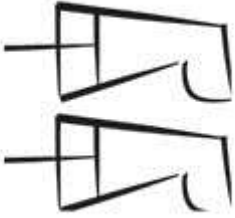
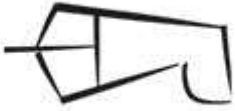

| Sign Name | Non-Numerical Sign Form |
|------------------|---|
| GÌR×ŠÈ |  |
| GIR ₄ |  |
| GISAL |  |
| GISAL |  |
| GIŠ |  |

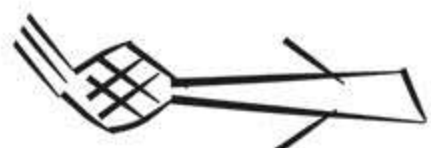
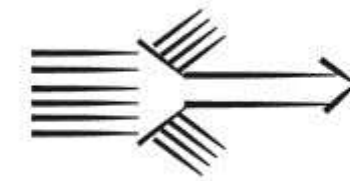

| Sign Name | Non-Numerical Sign Form |
|------------|---|
| GIŠ.TE |  |
| GIŠ-tenû.É |  |
| GIŠ-tenû |  |
| GIŠ |  |

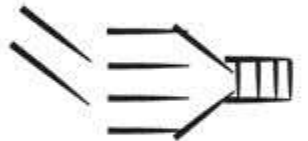
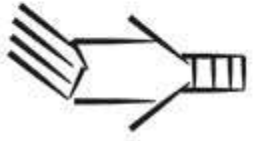
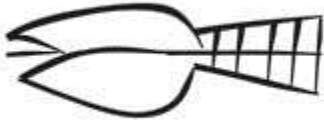

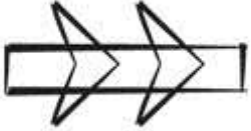
| Sign Name | Non-Numerical Sign Form |
|-----------|---|
| GÌŠ |  |
| GÌŠ&GÌŠ |  |
| GÌŠ |  |

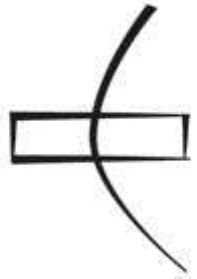
| Sign Name | Non-Numerical Sign Form |
|-----------|---|
| GIŠGAL |  |
| GIŠIMMAR |  |
| GIŠIMMAR |  |

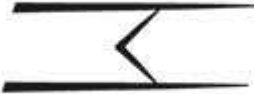
| Sign Name | Non-Numerical Sign Form |
|-----------|--|
| GIŠIMMAR |  |
| GIŠIMMAR |    |
| GIŠIMMAR |  |

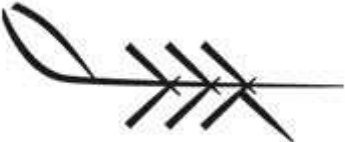
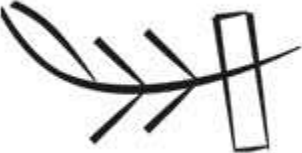
| Sign Name | Non-Numerical Sign Form |
|----------------|---|
| GIŠ× (DIN.DIN) |  |
| GIŠ× (DIN.DIN) |  |
| GIŠ× (DIN.DIN) |  |
| GIŠ×ŠÚ |  |

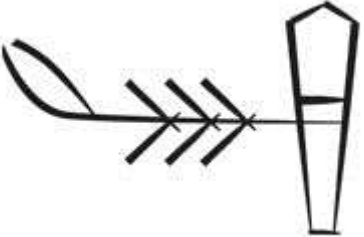

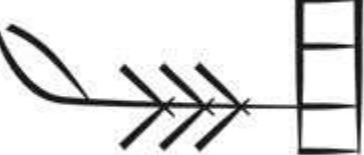
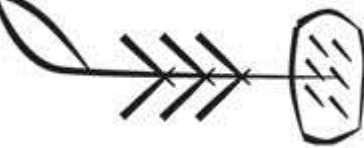
| Sign Name | Non-Numerical Sign Form |
|-------------|--|
| GIŠ×ŠÚ |  |
| GI×1 |  |
| GI×1-tenû |  |
| GI×GIŠ-tenû |  |

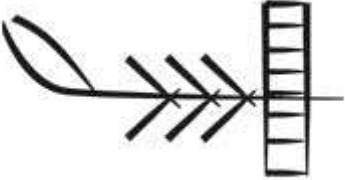
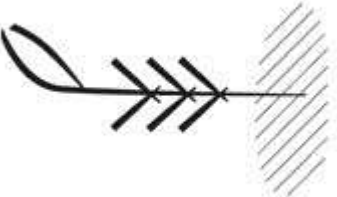
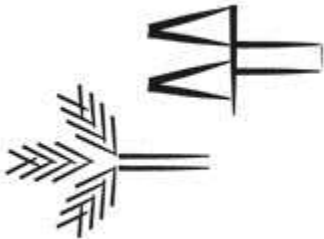
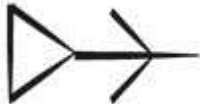

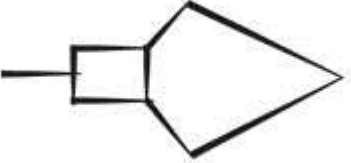
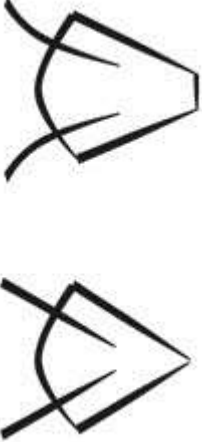
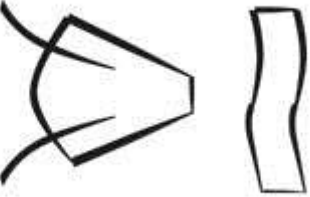
| Sign Name | Non-Numerical Sign Form |
|-----------|---|
| GI×KU |  |
| GI×LAGAB |  |
| GI×NÁM |  |
| GI×SÍG |  |

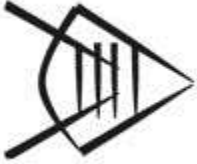
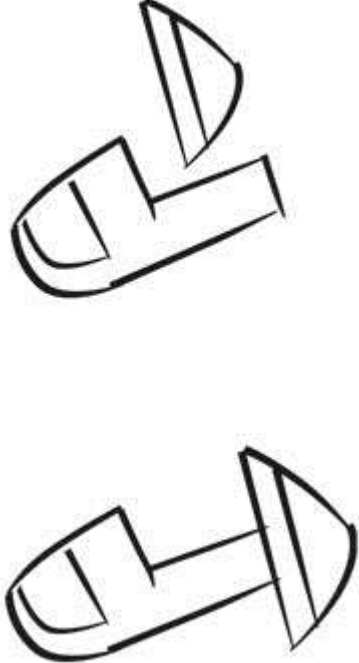

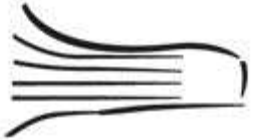
| Sign Name | Non-Numerical Sign Form |
|-----------|---|
| GI×ŠÈ |  |
| GI×X |  |
| GIZZAL |  |
| GU |  |



| Sign Name | Non-Numerical Sign Form |
|---------------------------|---|
| GÚ |  |
| GU ₄ |  |
| GU ₄ . ZATU755 |  |



| Sign Name | Non-Numerical Sign Form |
|-----------------------|--|
| GU ₄ -tenû |  |
| GU ₇ |  |

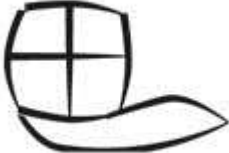

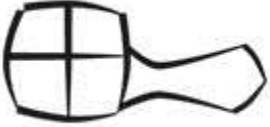
| Sign Name | Non-Numerical Sign Form |
|-----------|---|
| GÙB |  |
| GÙB |  |
| GÙB |  |
| GÙB |  |



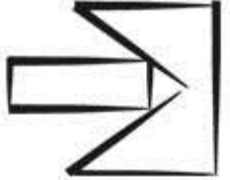

| Sign Name | Non-Numerical Sign Form |
|-----------|--|
| GÚG |  |
| GÚG-tenû |  |
| GÚG×SÌLA |  |

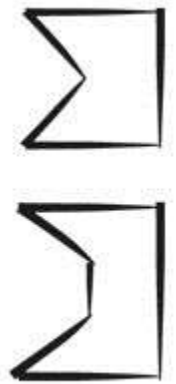

| Sign Name | Non-Numerical Sign Form |
|--------------------|---|
| GÚG×ŠITA |  |
| GÚG×TUR |  |
| GUKKAL . ȚI - gunû |  |
| GUKKAL |  |



| Sign Name | Non-Numerical Sign Form |
|-----------|---|
| GUKKAL |  |
| GUKKAL |  |
| GUKKAL |  |
| GUL |  |

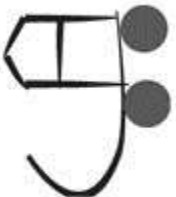

| Sign Name | Non-Numerical Sign Form |
|-----------|---|
| GUM |  |
| GUM |   |

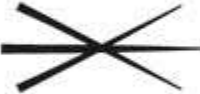
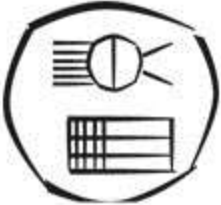

| Sign Name | Non-Numerical Sign Form |
|-------------|---|
| GUM-nutillû |  |
| GÙN |  |
| GÙN |  |

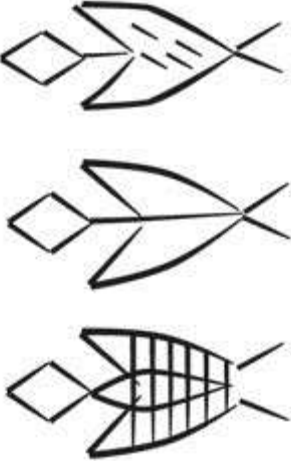

| Sign Name | Non-Numerical Sign Form |
|-----------|--|
| GUR |  |
| GURUŠ |   |
| GURUŠ×2 |  |



| Sign Name | Non-Numerical Sign Form |
|-----------|---|
| GURUŠ |  |
| GURUŠ×2 |  |
| GURUŠ×2 |  |
| GURUŠDA |  |

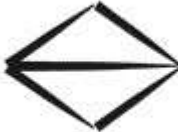

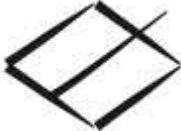
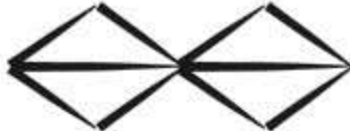
| Sign Name | Non-Numerical Sign Form |
|--|---|
| <p data-bbox="655 256 774 310">ḪAL</p> |  |
| <p data-bbox="620 532 817 586">ḪALUB</p> |  |
| <p data-bbox="602 813 835 867">ḪAŠḪUR</p> |  |
| <p data-bbox="540 1062 897 1115">ḪAŠḪUR×MA</p> |  |

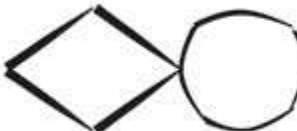

| Sign Name | Non-Numerical Sign Form |
|---|---|
| <p data-bbox="674 272 755 334">HI</p> |  |
| <p data-bbox="559 699 881 761">HI . SUHUR</p> |  |
| <p data-bbox="580 1122 860 1183">HI-gunû</p> |  |

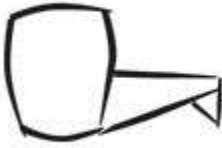
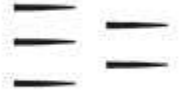

| Sign Name | Non-Numerical Sign Form |
|-----------|---|
| ḤI-gunû |  |
| ḤI-gunû |  |
| ḤI×1-flat |  |
| ḤI×1 |  |

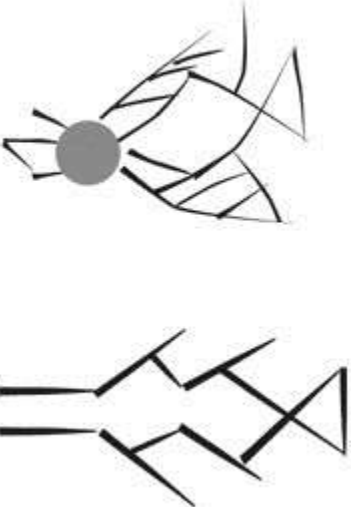

| Sign Name | Non-Numerical Sign Form |
|---|---|
| $\text{H}I \times 1 - \text{ten} \hat{u}$ |  |
| $(\text{H}I \times 1) \cdot (\text{H}I \times 1)$ |  |
| $\text{H}I \times 1$ |  |
| $\text{H}I \times \text{LAGAB}$ |  |

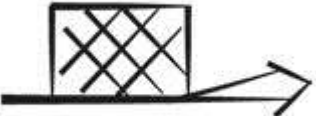
| Sign Name | Non-Numerical Sign Form |
|-------------------|---|
| <p>ḤI×ŠÈ-tenû</p> |  |
| <p>ḤI×ZATU707</p> |  |
| <p>ḤÚB</p> |  |
| <p>I</p> |  |



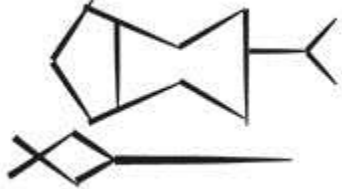
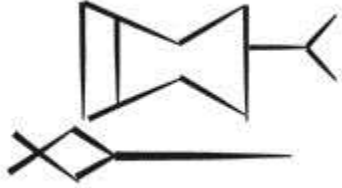

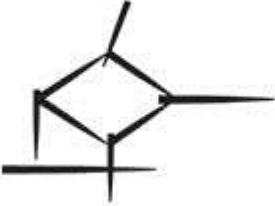
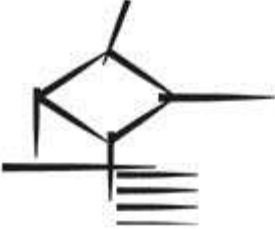
| Sign Name | Non-Numerical Sign Form |
|------------|--|
| IB |  |
| IB-nutillû |  |
| IB |  |

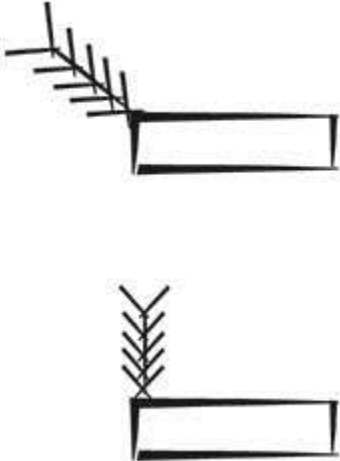
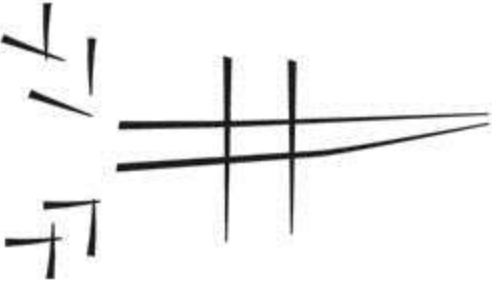

| Sign Name | Non-Numerical Sign Form |
|-----------|---|
| IDIGNA |  |
| IG |  |
| IG |  |

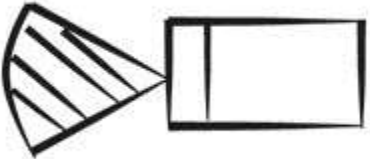

| Sign Name | Non-Numerical Sign Form |
|-----------|---|
| IGI |  |
| IL |  |
| ILDUM |  |
| ILDUM |  |

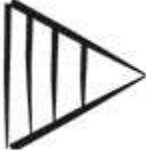
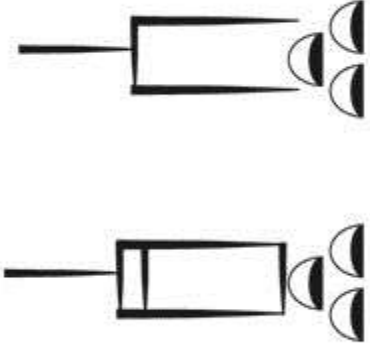

| Sign Name | Non-Numerical Sign Form |
|-----------|--|
| IM |  |
| IM-gunû |  |
| IM |  |

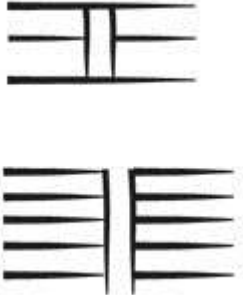

| Sign Name | Non-Numerical Sign Form |
|---------------------------------------|--|
| <p data-bbox="682 440 755 483">IN</p> |  |
| <p data-bbox="682 935 755 979">IN</p> |  |

| Sign Name | Non-Numerical Sign Form |
|-----------|---|
| IR.GÁ |  |
| IR |  |
| IR |  |
| IR |  |

| Sign Name | Non-Numerical Sign Form |
|------------------|--|
| IR |  |
| IR ₁₁ |  |
| IRḤAN |  |

| Sign Name | Non-Numerical Sign Form |
|-----------|--|
| IŠ |  |
| IŠ |  |

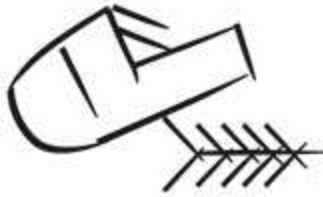
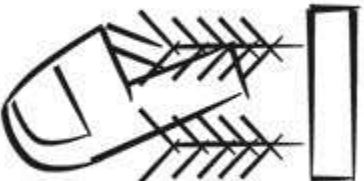

| Sign Name | Non-Numerical Sign Form |
|-----------|--|
| IŠ |  |
| IŠ |  |

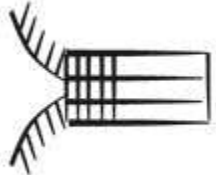
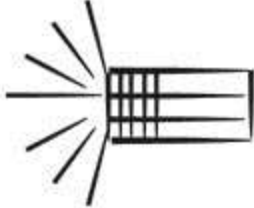
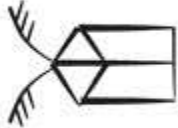
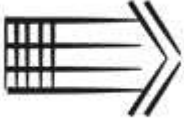

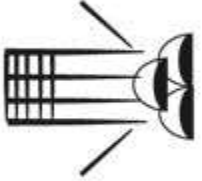
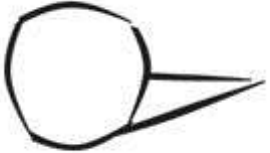
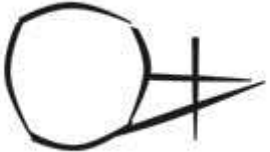
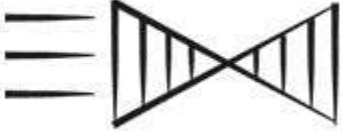
| Sign Name | Non-Numerical Sign Form |
|-----------|---|
| KA |  |
| KA.ŠE |   |
| KA×SAR |  |

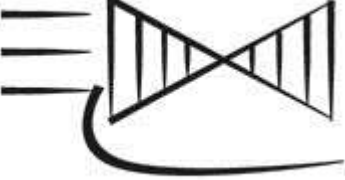
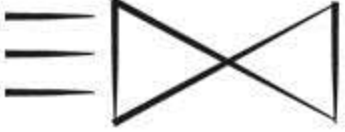
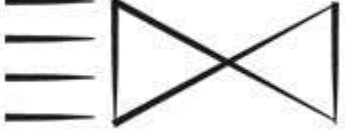
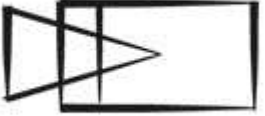

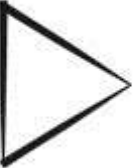
| Sign Name | Non-Numerical Sign Form |
|-----------|---|
| KÁ |  |
| KÁ |  |
| KÁ |  |
| KÁ |  |

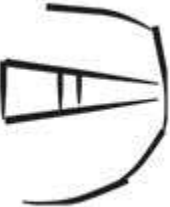

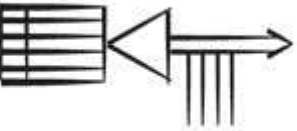
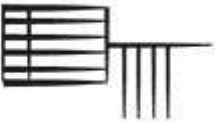

| Sign Name | Non-Numerical Sign Form |
|------------------|---|
| KÁ×LAM |  |
| KAB |  |
| KAB×1 |  |
| KAD ₄ |  |

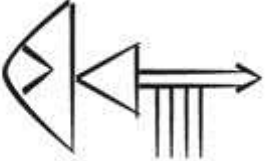
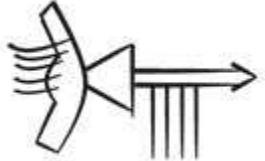
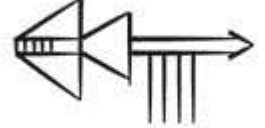
| Sign Name | Non-Numerical Sign Form |
|------------------|---|
| KAD ₄ |  |
| KAD ₄ |  |
| KAD ₄ |  |
| KAK . GÁ |  |

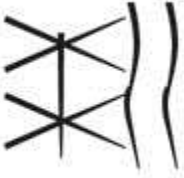

| Sign Name | Non-Numerical Sign Form |
|-----------|---|
| KAK |  |
| KAK |  |
| KAL |  |

| Sign Name | Non-Numerical Sign Form |
|-----------|---|
| KAL |  |
| KAL |  |
| KALAM |  |
| KALAM |  |

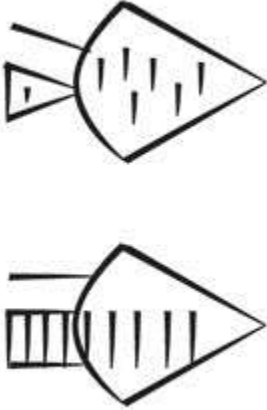

| Sign Name | Non-Numerical Sign Form |
|-----------|---|
| KALAM |  |
| KALAM |  |
| KALAM |  |
| KALAM |  |

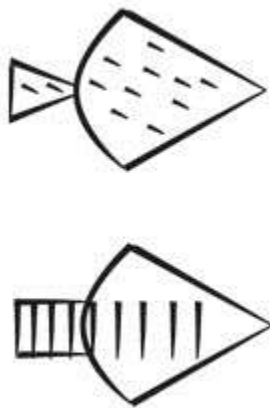

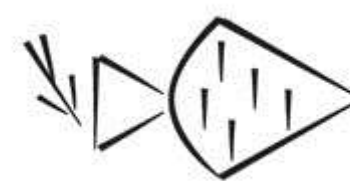
| Sign Name | Non-Numerical Sign Form |
|-----------|---|
| KAR |  |
| KÁR |  |
| KÁR |  |
| KASKAL |  |

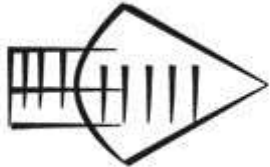
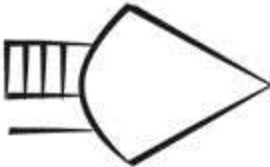
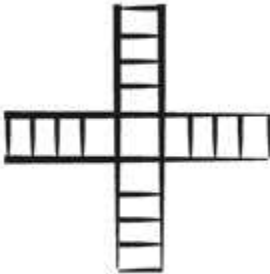

| Sign Name | Non-Numerical Sign Form |
|-------------|---|
| KASKAL-gunû |  |
| KAŠ |  |

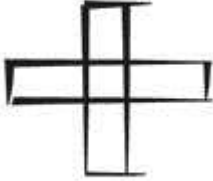

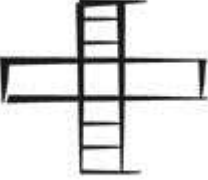
| Sign Name | Non-Numerical Sign Form |
|-----------|---|
| KAŠ |  |
| KAŠ-tenû |  |
| KAŠ×ŠE |  |

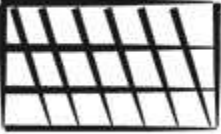
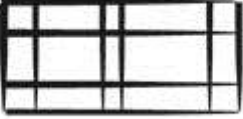
| Sign Name | Non-Numerical Sign Form |
|-----------|--|
| KAŠ |  |
| KAŠ |  |
| KÉŠ |  |

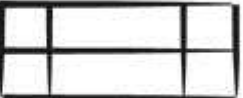
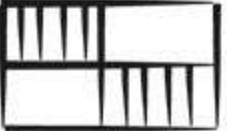
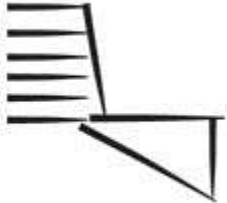

| Sign Name | Non-Numerical Sign Form |
|----------------|---|
| KI |  |
| KI-nutillû |  |
| KI-nutillû×DUB |  |
| KIB |  |

| Sign Name | Non-Numerical Sign Form |
|-----------|---|
| KIB-gunû |  |
| KID |  |
| KID |  |
| KID |  |

| Sign Name | Non-Numerical Sign Form |
|-----------|---|
| KID |  |
| KID |  |
| KIN |  |
| KÍN |  |

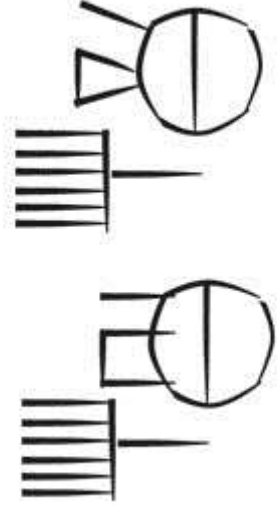
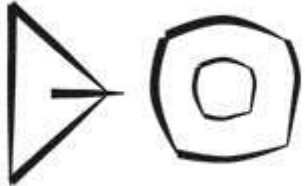
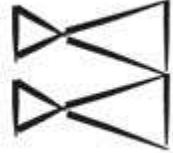

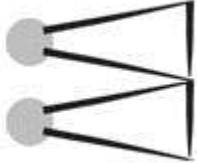
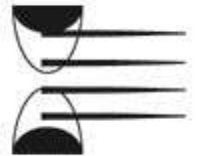
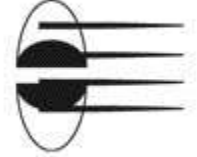
| Sign Name | Non-Numerical Sign Form |
|-----------|---|
| KÍN |  |
| KÍN |  |
| KÍN |  |

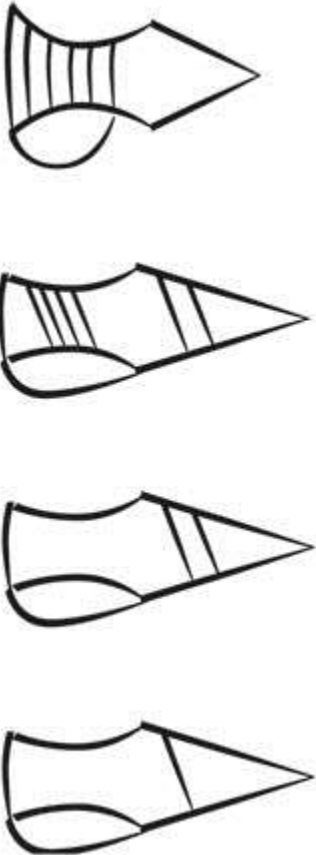
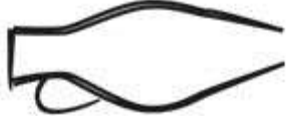

| Sign Name | Non-Numerical Sign Form |
|-------------------|---|
| KINGAL |  |
| KIR ₁₁ |  |
| KISAL |  |

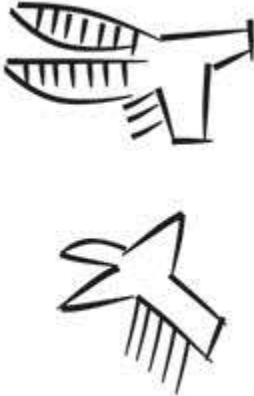
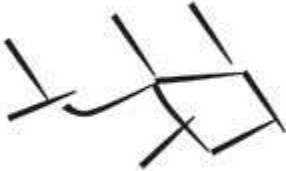
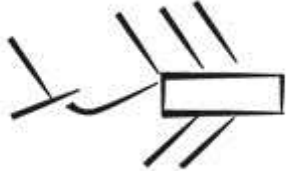

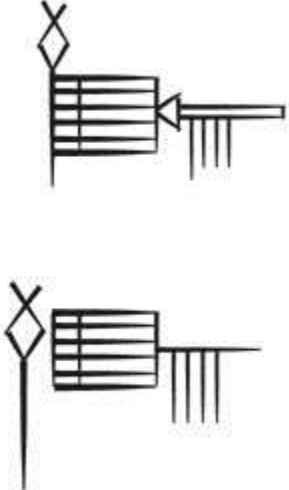
| Sign Name | Non-Numerical Sign Form |
|------------|---|
| KISAL |  |
| KISAL |  |
| KISAL |  |
| KISAL-tenû |  |



| Sign Name | Non-Numerical Sign Form |
|--|---|
| <p data-bbox="612 630 822 678">KISIM</p> |  |
| <p data-bbox="612 1247 822 1295">KISIM</p> |  |



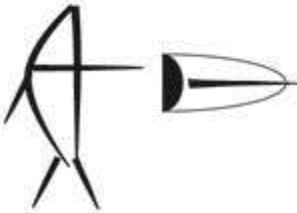

| Sign Name | Non-Numerical Sign Form |
|-----------|---|
| KIŠ |  |
| KIŠIK |  |
| KIŠIK |  |

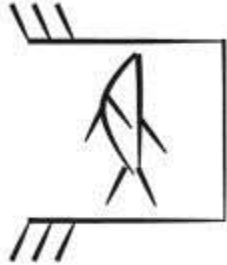

| Sign Name | Non-Numerical Sign Form |
|--|---|
| <p data-bbox="639 451 795 500">KITI</p> |  |
| <p data-bbox="677 933 758 982">KU</p> |  |
| <p data-bbox="577 1201 854 1250">KU-tenû</p> |  |



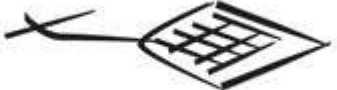

| Sign Name | Non-Numerical Sign Form |
|-----------|--|
| KU |  |
| KU |  |
| KÙ |  |

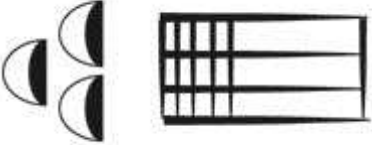

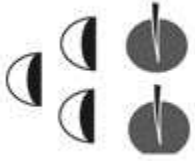

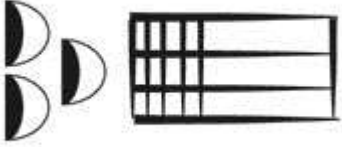
| Sign Name | Non-Numerical Sign Form |
|--------------------|--|
| KÙ |  |
| KU ₆ .1 |  |
| KU ₆ |  |





| Sign Name | Non-Numerical Sign Form |
|--|--|
| <p data-bbox="524 337 908 394">KU₆-šeššig</p> |  |
| <p data-bbox="585 695 846 751">KU₆+GIŠ</p> |  |
| <p data-bbox="594 1036 838 1092">KU₆+KU₆</p> |  |



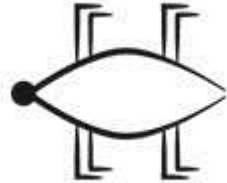

| Sign Name | Non-Numerical Sign Form |
|-----------------|---|
| KU ₆ |  |
| KU ₆ |  |
| KUN |  |
| KUR-gunû |  |





| Sign Name | Non-Numerical Sign Form |
|-----------|---|
| KUR-gunû |  |
| KUR.É |  |
| KUR |  |
| KUR.NUNUZ |  |





| Sign Name | Non-Numerical Sign Form |
|-----------|---|
| KUR.É |  |
| KUR |  |
| KUR |  |
| KUR |  |





| Sign Name | Non-Numerical Sign Form |
|-----------|--|
| KÚŠU |  |
| KÚŠU |  |
| KÚŠU |  |
| KÚŠU |  |





| Sign Name | Non-Numerical Sign Form |
|-----------|---|
| KÚŠU |  |
| KÚŠU |  |
| LA |  |
| LA |  |

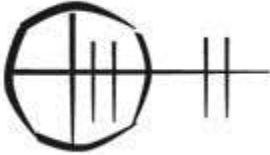



| Sign Name | Non-Numerical Sign Form |
|-----------|---|
| LA |  |
| LA |  |
| LÁ |  |
| LAGAB |  |



| Sign Name | Non-Numerical Sign Form |
|-----------------------|---|
| LAGAB×2 |  |
| LAGAB×BA |  |
| LAGAB×BÌR |  |
| LAGAB×DU ₆ |  |

| Sign Name | Non-Numerical Sign Form |
|--|---|
| LAGAB×KAK |  |
| LAGAB×KU ₆ |  |
| LAGAB× (KU ₆ +KU ₆) |  |
| LAGAB×KÚŠU |  |



| Sign Name | Non-Numerical Sign Form |
|-------------|---|
| LAGAB×LAGAB |  |
| LAGAB×ME |  |
| LAGAB×NUN |  |
| LAGAB×PA |  |

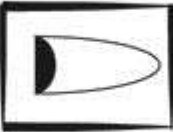

| Sign Name | Non-Numerical Sign Form |
|------------------------|---|
| LAGAB×SI |  |
| LAGAB×SIG ₇ |  |
| LAGAB×SU |  |
| LAGAB×ŠA |  |

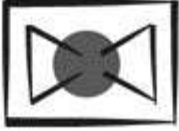
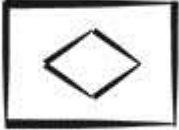
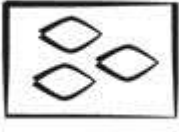

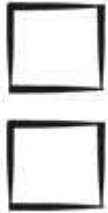
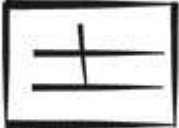

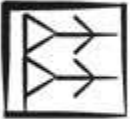
| Sign Name | Non-Numerical Sign Form |
|----------------------|---|
| LAGAB×ŠITA |  |
| LAGAB×TI |  |
| LAGAB×U ₄ |  |
| LAGAB×UB |  |

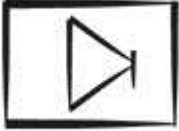
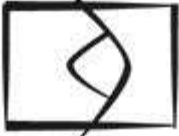

| Sign Name | Non-Numerical Sign Form |
|---------------|---|
| LAGAB×X |  |
| LAGAB×ZATU753 |  |
| LAGAB |  |
| LAGAB×1 |  |



| Sign Name | Non-Numerical Sign Form |
|--------------------------|---|
| LAGAB×BANŠUR |  |
| LAGAB×GA ³ AR |  |
| LAGAB×ĦI |  |
| LAGAB×KUR |  |

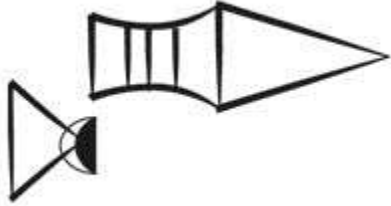
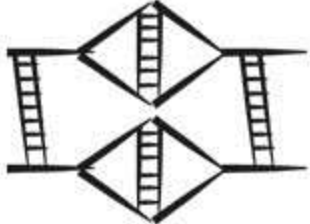
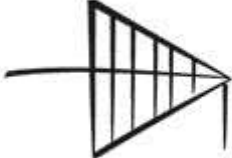

| Sign Name | Non-Numerical Sign Form |
|-------------|---|
| LAGAB×LAGAB |  |
| LAGAB×PA |  |
| LAGAB×SI |  |
| LAGAB×SÙḪ |  |

| Sign Name | Non-Numerical Sign Form |
|----------------------|---|
| LAGAB×ŠITA |  |
| LAGAB×U ₄ |  |
| LAGAB×X |  |
| LAGAR |  |

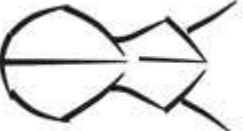
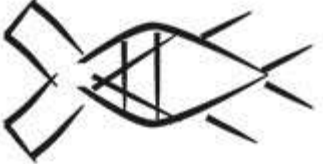
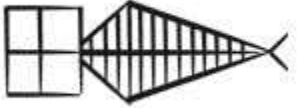

| Sign Name | Non-Numerical Sign Form |
|----------------------------|--|
| LAGAR-vertically reflected |  |
| LAGAR |  |
| LAGAR |  |
| LAGAR |  |

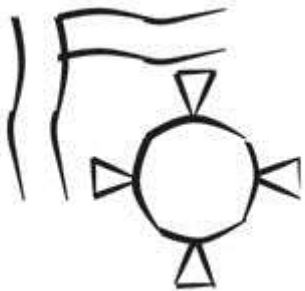

| Sign Name | Non-Numerical Sign Form |
|-----------|---|
| LÁŦTAN |  |
| LAK025 |  |
| LAK050 |  |
| LAK172 |  |



| Sign Name | Non-Numerical Sign Form |
|-----------|---|
| LAK251 |  |
| LAK350 |  |
| LAK777 |  |
| LÁL |  |

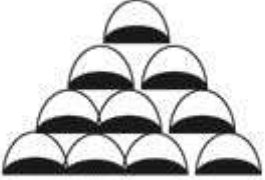

| Sign Name | Non-Numerical Sign Form |
|-----------|--|
| LÁL×EZEN |  |
| LÁL×NIM |  |
| LÁL |  |

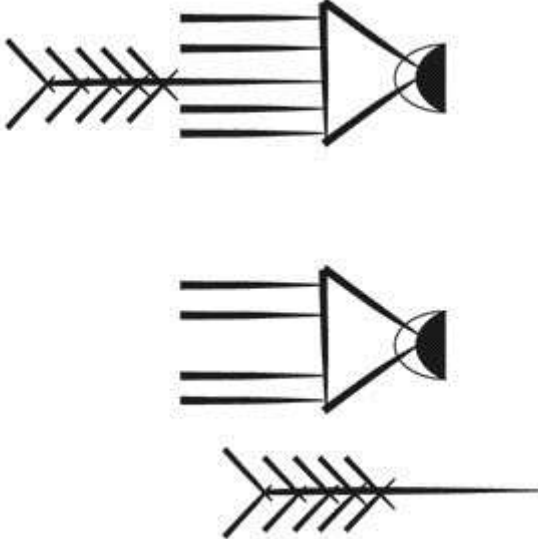

| Sign Name | Non-Numerical Sign Form |
|-----------|--|
| LÀL | <p>A hand sign for 'LÀL' showing a hand with the index finger pointing left, the thumb pointing up, and the other three fingers curled. A vertical rectangular bar is positioned to the right of the hand.</p> |
| LÀL | <p>A hand sign for 'LÀL' showing a hand with the index finger pointing left, the thumb pointing up, and the other three fingers curled. A vertical rectangular bar is positioned to the right of the hand.</p> |
| LÀL | <p>A hand sign for 'LÀL' showing a hand with the index finger pointing left, the thumb pointing up, and the other three fingers curled.</p> |
| LAM | <p>A hand sign for 'LAM' showing a hand with the index finger pointing up and the other four fingers curled.</p> |

| Sign Name | Non-Numerical Sign Form |
|---------------------------------|---|
| <p>LAM</p> |  |
| <p>LAM-vertically reflected</p> |  |

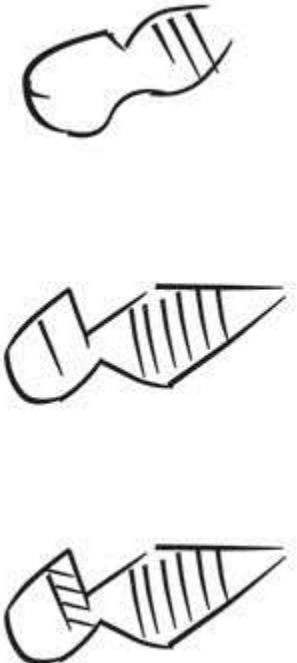

| Sign Name | Non-Numerical Sign Form |
|------------|--|
| LAM-šeššig |  |
| LAM-tenû |  |
| LAM |  |

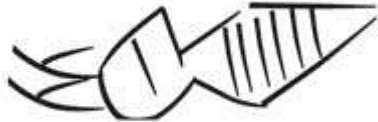
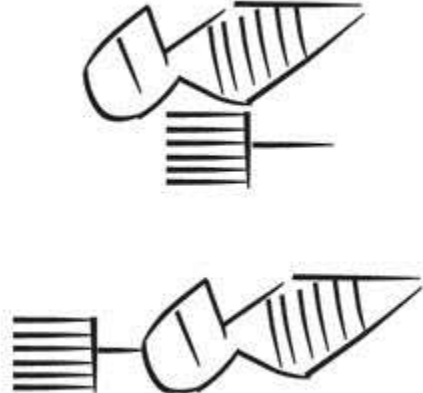
| Sign Name | Non-Numerical Sign Form |
|---|--|
| <p data-bbox="674 480 755 526">LI</p> |  |
| <p data-bbox="655 954 779 1013">LIŠ</p> |  |

| Sign Name | Non-Numerical Sign Form |
|----------------|---|
| <p>LÚ</p> |  |
| <p>LÚ-tenû</p> |  |

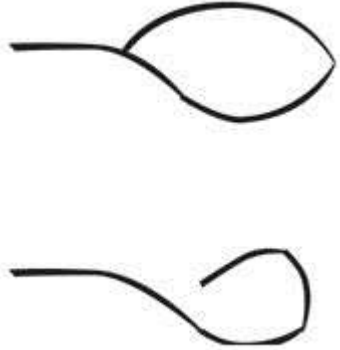
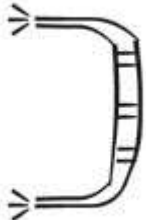
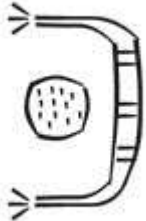

| Sign Name | Non-Numerical Sign Form |
|-----------|---|
| LÚ×GEŠTU |  |
| LUGAL |  |
| LUM |  |

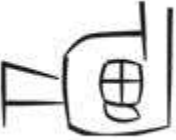
| Sign Name | Non-Numerical Sign Form |
|-----------|---|
| MA |  |
| MÁ |  |
| MAGUR |  |

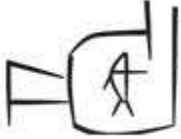
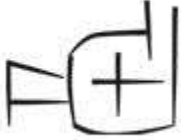
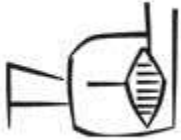
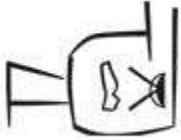
| Sign Name | Non-Numerical Sign Form |
|--------------|---|
| MAGUR |  |
| MAḤ |  |
| MAḤ × ÁB |  |
| MAḤ × GUKKAL |  |

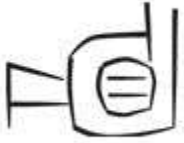
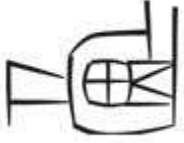
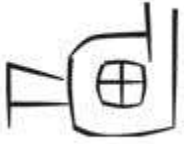
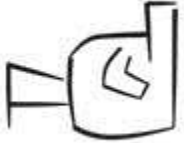

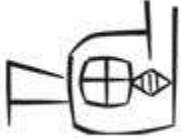
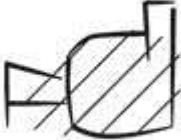
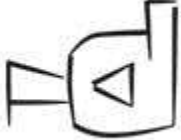
| Sign Name | Non-Numerical Sign Form |
|-----------------------|---|
| MAḤ × KU ₆ |  |
| MAḤ × MAŠ |  |
| MAḤ × NA |  |
| MAḤ × (SÌLA × UMBIN) |  |

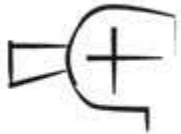
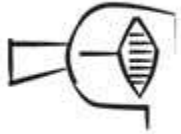
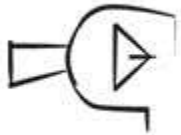

| Sign Name | Non-Numerical Sign Form |
|-----------------------|---|
| MAḤ × TÚG |  |
| MAḤ × UD ₅ |  |
| MAḤ × UDU |  |
| MAḤ × UR |  |

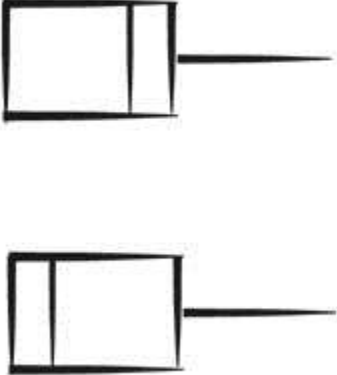
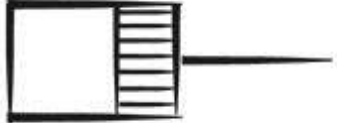
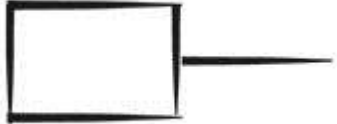

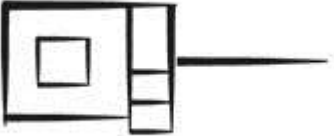
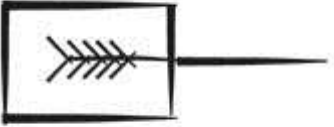
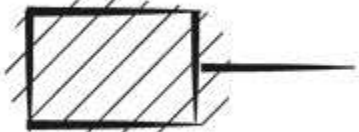

| Sign Name | Non-Numerical Sign Form |
|-------------|---|
| MAḤ×UTUA |  |
| MAḤ×X |  |
| MAḤ×ZATU659 |  |
| MAḤ |  |

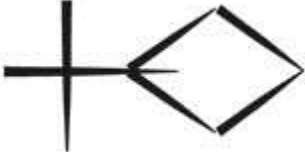
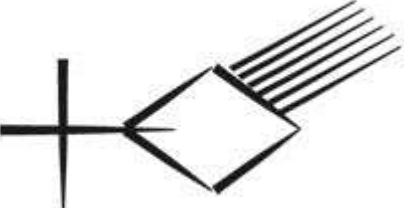

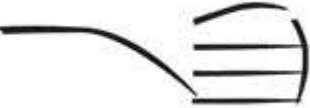
| Sign Name | Non-Numerical Sign Form |
|-----------------------|---|
| MAḤ × KU ₆ |  |
| MAḤ × MAŠ |  |
| MAḤ × NA |  |
| MAḤ × SAL |  |



| Sign Name | Non-Numerical Sign Form |
|-----------|--|
| MAR |  |
| MAR-tenû |  |
| MAR |  |



| Sign Name | Non-Numerical Sign Form |
|-----------------|---|
| MAR× (LAGAB.ŠÈ) |  |
| MAR× ŠE |  |
| MAR× X |  |
| MAŠ |  |

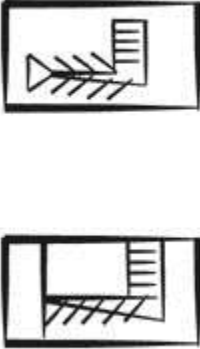

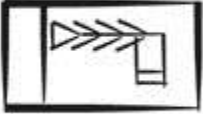
| Sign Name | Non-Numerical Sign Form |
|-----------|---|
| MÁŠ |  |
| MÁŠ-gunû |  |
| MA×1 |  |
| MA×2 |  |

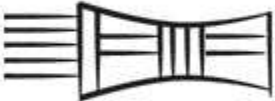
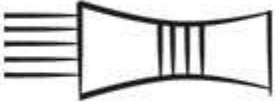

| Sign Name | Non-Numerical Sign Form |
|-----------|---|
| MA × A |  |
| MA × MA |  |
| MA × X |  |
| ME |  |

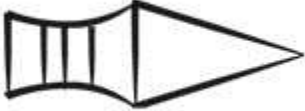

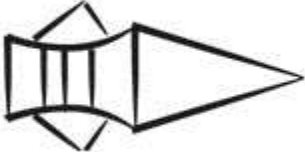
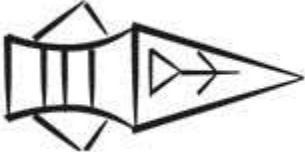
| Sign Name | Non-Numerical Sign Form |
|-----------|--|
| ME |  |
| MÈ |  |
| MEN |  |

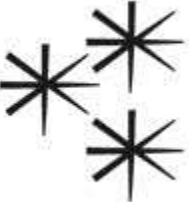
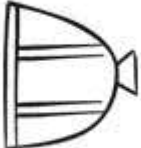

| Sign Name | Non-Numerical Sign Form |
|-----------|--|
| MEN |  |
| MES |   |
| MIR |  |
| MIR |  |

| Sign Name | Non-Numerical Sign Form |
|-----------|---|
| MU |  |
| MUD |   |
| MÙD |  |

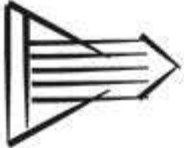
| Sign Name | Non-Numerical Sign Form |
|-------------|---|
| MÙD-gunû |  |
| MÙD-gunû×GU |  |
| MÙD |  |
| MÙD |  |

| Sign Name | Non-Numerical Sign Form |
|-----------|---|
| MÙD |  |
| MUL |  |
| MUN |  |
| MUN |  |

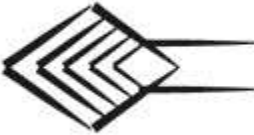
| Sign Name | Non-Numerical Sign Form |
|-----------|---|
| MUN |  |
| MUN |  |
| MUN |  |
| MUNŠUB |  |

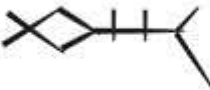
| Sign Name | Non-Numerical Sign Form |
|-----------|---|
| MUNŠUB |  |
| MÙNU |  |
| MÚRUB |  |
| MUŠ |  |

Sign Name



Non-Numerical Sign Form

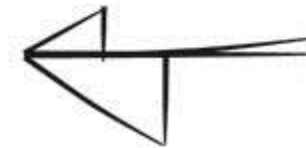

MÙŠ







MÙŠ-gunû



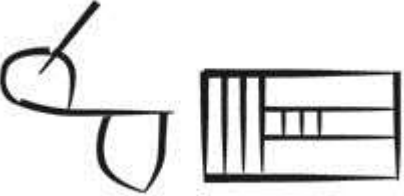

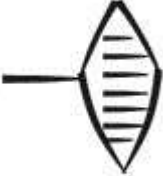

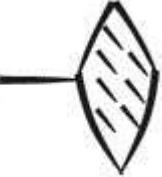
| Sign Name | Non-Numerical Sign Form |
|-----------|--|
| MÙŠ |  |
| MUŠEN |  |
| MUŠEN. ÛR |  |



| Sign Name | Non-Numerical Sign Form |
|-----------|---|
| MUŠEN×1 |  |
| MUŠEN×2 |  |
| MUŠEN×3 |  |

| Sign Name | Non-Numerical Sign Form |
|-----------|--|
| MUŠEN×PAP |  |
| MUŠEN×X |  |
| NA |  |

| Sign Name | Non-Numerical Sign Form |
|-----------|--|
| NA |  |
| NA |  |
| NA |  |

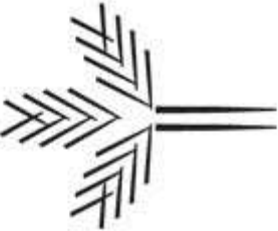
| Sign Name | Non-Numerical Sign Form |
|-----------|---|
| NÁ |  |
| NÁ |  |
| NÁ |  |

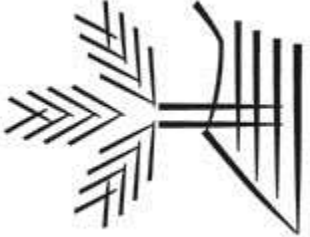
| Sign Name | Non-Numerical Sign Form |
|---|---|
| <p data-bbox="655 570 774 613">NAB</p> |  |
| <p data-bbox="639 1175 790 1219">NAGA</p> |  |



| Sign Name | Non-Numerical Sign Form |
|-----------------------|---|
| NAGA×TAK ₄ |  |
| NAGA |  |



Sign Name

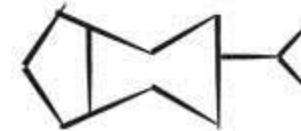
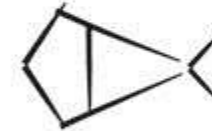
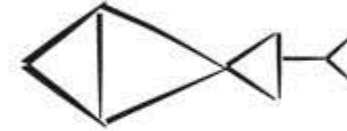
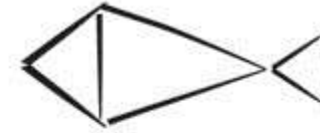

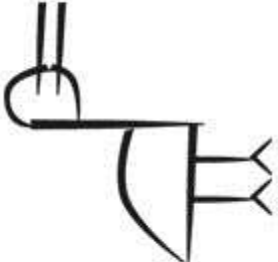
Non-Numerical Sign Form

NAGAR

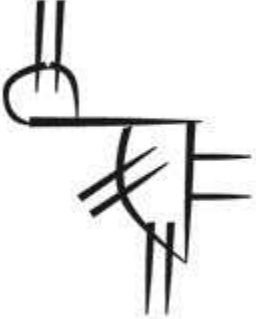
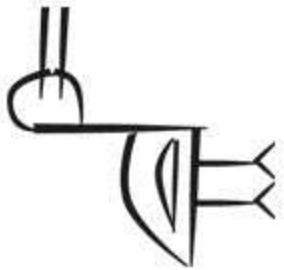



| Sign Name | Non-Numerical Sign Form |
|-----------|---|
| NAGAR |  <p>The first sign form is a stylized representation of a village or town, featuring a central structure with a pointed roof and a small chimney-like element on the right. The second sign form is a stylized representation of a village or town, featuring a central structure with a pointed roof and a small chimney-like element on the right.</p> |
| NAM |  <p>The sign form is a stylized representation of a person or figure, possibly a deity or a specific character, with a prominent head and a body that tapers towards the bottom.</p> |
| NAM |  <p>The sign form is a stylized representation of a bird or a creature with wings, possibly a phoenix or a similar mythical creature, with a long neck and a tail.</p> |

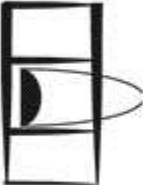

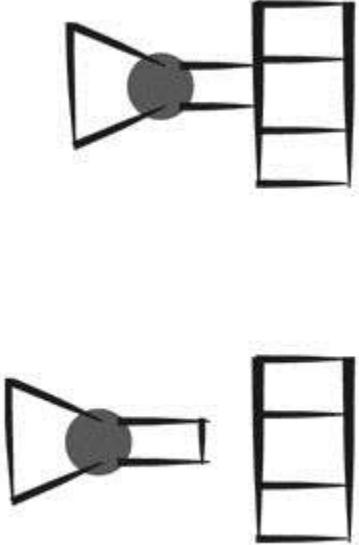
| Sign Name | Non-Numerical Sign Form |
|-----------|---|
| NAM |  |
| NAM |  |
| NĂM |  |

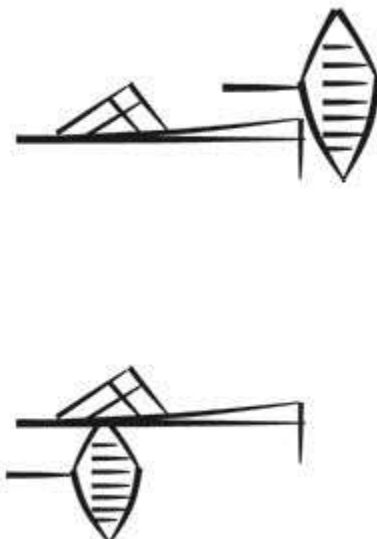
| Sign Name | Non-Numerical Sign Form |
|-----------|---|
| NĂM-gunû |  |
| NĂM-tenû |  |
| NĂM×1 |  |

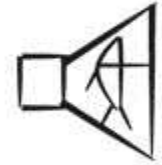
| Sign Name | Non-Numerical Sign Form |
|-----------|---|
| NAMEŠDA |  |

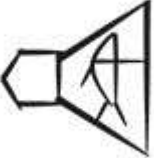

| Sign Name | Non-Numerical Sign Form |
|-----------|---|
| NANNA |  |
| NANNA |  |
| NANŠE |  |



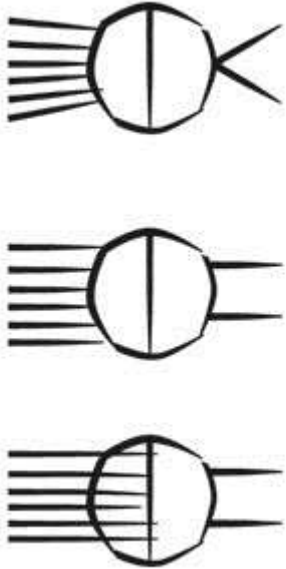
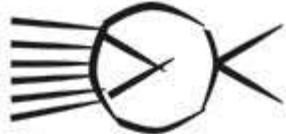
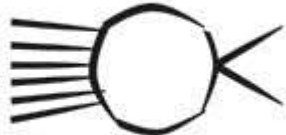

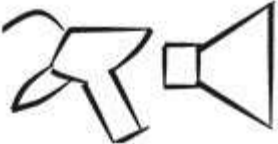
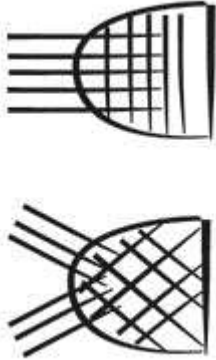

| Sign Name | Non-Numerical Sign Form |
|-----------|---|
| NANŠE |  |
| NAR |  |

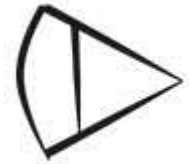

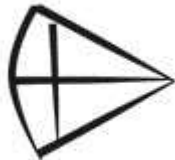

| Sign Name | Non-Numerical Sign Form |
|-----------|---|
| NE |  |
| NE |  |
| NE |  |

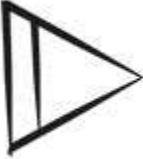
| Sign Name | Non-Numerical Sign Form |
|-----------|--|
| NE |  |
| NERGAL |  |
| NÉSAG |  |

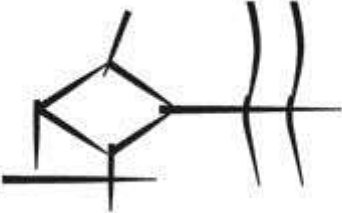
| Sign Name | Non-Numerical Sign Form |
|------------|---|
| NÉSAG |  |
| NÉSAG-tenû |  |
| NI |  |

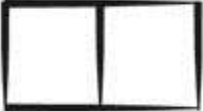
| Sign Name | Non-Numerical Sign Form |
|-----------|--|
| NI .RU |  |
| NI-gunû |  |
| NI×1 |  |

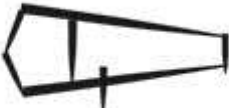

| Sign Name | Non-Numerical Sign Form |
|-----------|---|
| NI |  |
| NI × 4 |  |
| NI × X |  |
| NÍ |  |

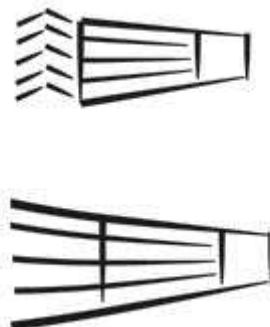
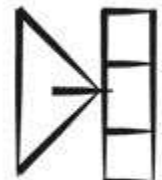
| Sign Name | Non-Numerical Sign Form |
|-----------|---|
| NIGIN |  |
| NIM |  |
| NIM |  |
| NIM |  |
| NIM |  |

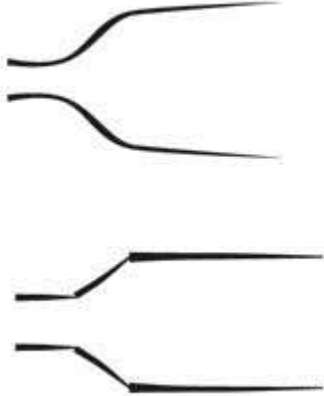
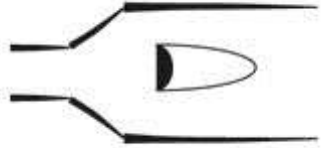
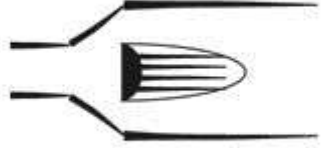
| Sign Name | Non-Numerical Sign Form |
|-----------|---|
| NIMGIR |  |
| NIN |  |

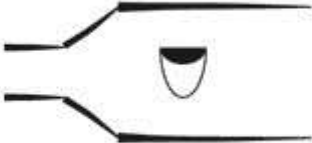
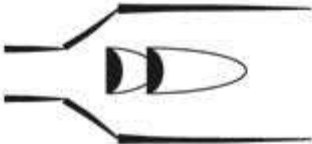
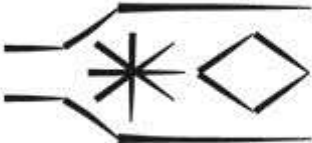
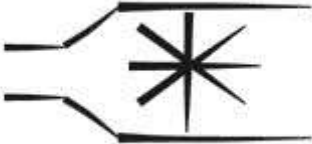

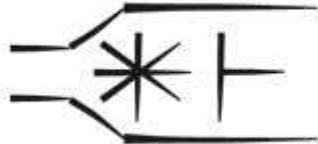
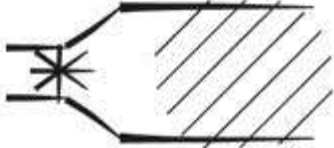
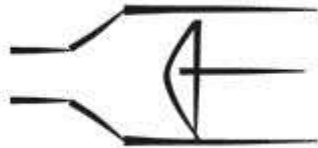
| Sign Name | Non-Numerical Sign Form |
|-----------|---|
| NÍNDA |  |
| NÍNDA×1 |  |
| NÍNDA×1 |  |

| Sign Name | Non-Numerical Sign Form |
|------------------|---|
| NÍNDA×1 |  |
| NÍNDA×2 |  |
| NÍNDA× (AN . ҒI) |  |
| NÍNDA×AN |  |

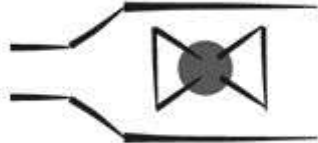
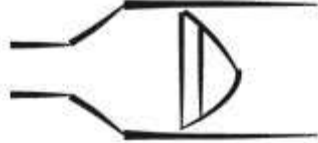
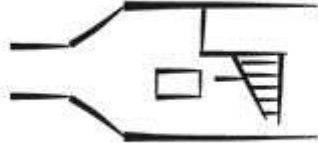
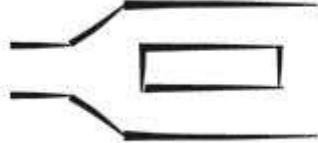
| Sign Name | Non-Numerical Sign Form |
|------------------|---|
| NÍNDA× (AN . ME) |  |
| NÍNDA× (AN . X) |  |
| NÍNDA×BA |  |
| NÍNDA×EZEN |  |

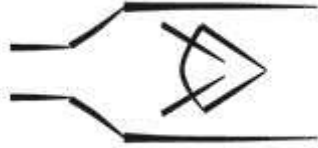
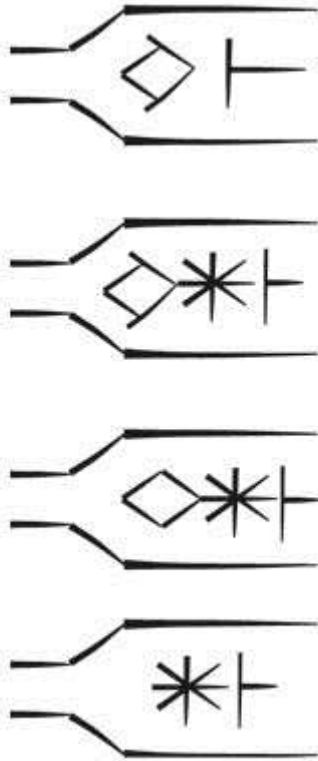
| Sign Name | Non-Numerical Sign Form |
|--------------------------|---|
| NÍNDA×GA ³ AR |  |
| NÍNDA×GAR |  |
| NÍNDA× (GIŠ . DAR) |  |
| NÍNDA×GIŠ |  |

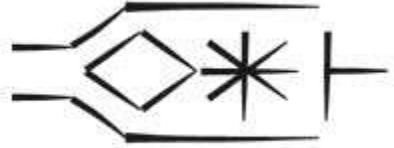
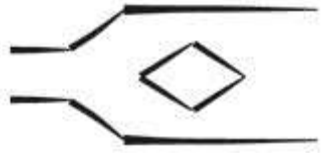
| Sign Name | Non-Numerical Sign Form |
|-------------------------|--|
| NÍNDA×GU ₄ |  |
| NÍNDA×GUDU ₄ |  |

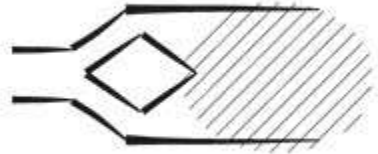

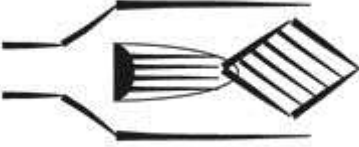
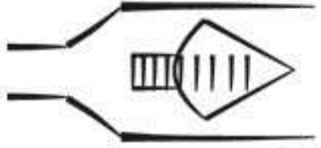
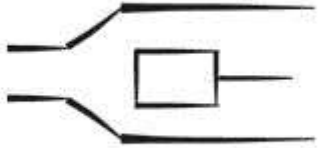
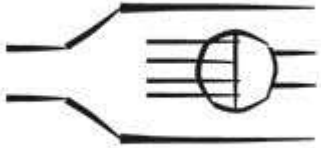
| Sign Name | Non-Numerical Sign Form |
|-----------------------|---|
| NÍNDA× (ḪI . AN . ME) |  |
| NÍNDA×ḪI |  |
| NÍNDA× (ḪI . ME) |  |
| NÍNDA× (ḪI . X) |  |

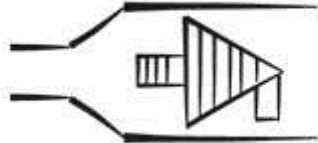
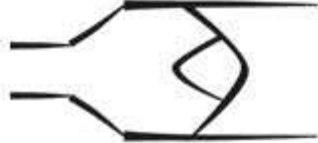
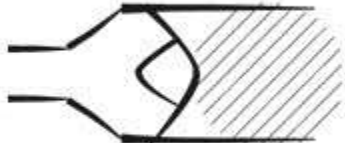
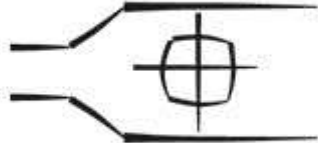

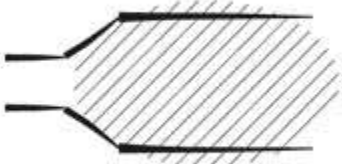
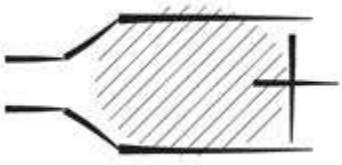
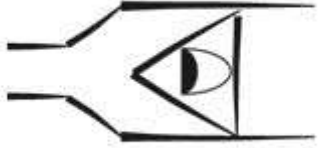

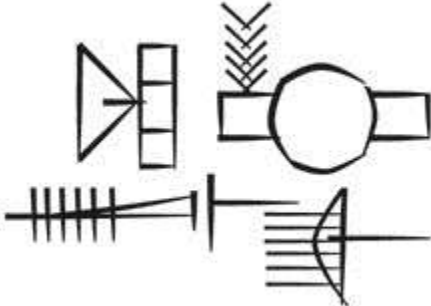
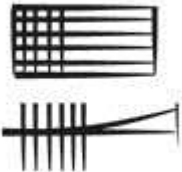
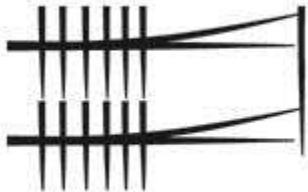
| Sign Name | Non-Numerical Sign Form |
|---------------------|---|
| NÍNDA× (ḪI-gunû .1) |  |
| NÍNDA×KAŠ |  |
| NÍNDA×MAR |  |
| NÍNDA×NE |  |

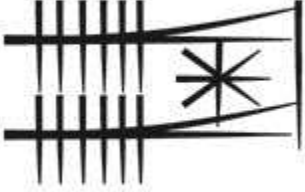
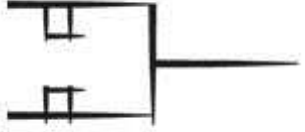

| Sign Name | Non-Numerical Sign Form |
|-----------------------------|---|
| NÍNDA×ŠIM |  |
| NÍNDA×U ₄ |  |
| NÍNDA× (U ₄ . X) |  |
| NÍNDA× (UDU×TAR) |  |

| Sign Name | Non-Numerical Sign Form |
|--------------------|---|
| NÍNDA×X |  |
| NÍNDA× (X.MAŠ) |  |
| NÍNDA× (ZATU659×1) |  |

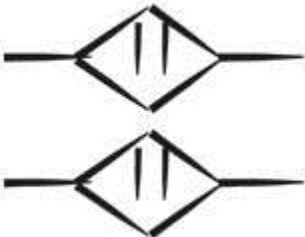
| Sign Name | Non-Numerical Sign Form |
|-----------|--|
| NINKUM |  <p>The sign form for NINKUM consists of four distinct pictorial elements. In the top left is a trapezoidal shape with a vertical line and a horizontal line extending from its right side. To its right is a circular shape with a vertical line through its center and a horizontal line extending from its right side. Below the trapezoid is a series of horizontal lines of varying lengths, resembling a comb or a fan. To the right of this is a vertical line with a horizontal line extending from its top, and below that is a series of horizontal lines of varying lengths, similar to the one on the left.</p> |
| NINLIL |  <p>The sign form for NINLIL consists of two elements. The top element is a rectangular shape with horizontal lines inside, resembling a grid or a window. The bottom element is a series of vertical lines of varying lengths, with a horizontal line extending from the top of the longest line to the right.</p> |
| NIR |  <p>The sign form for NIR consists of two elements. The top element is a series of vertical lines of varying lengths, with a horizontal line extending from the top of the longest line to the right. The bottom element is a series of vertical lines of varying lengths, with a horizontal line extending from the bottom of the longest line to the right.</p> |



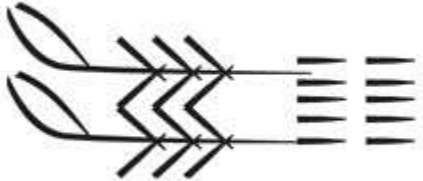

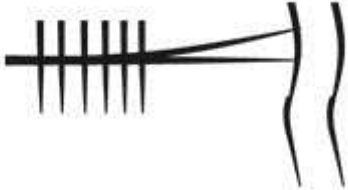
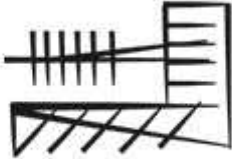
| Sign Name | Non-Numerical Sign Form |
|-----------|---|
| NIR×AN |  |
| NIR |  |
| NU |  |
| NU-gunû |  |

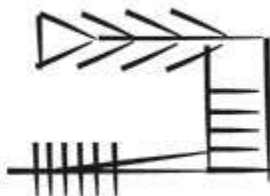
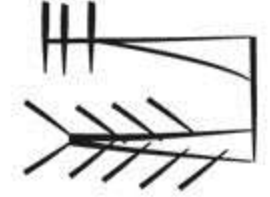
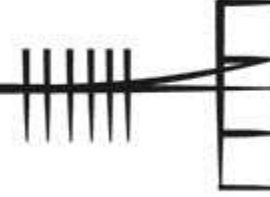
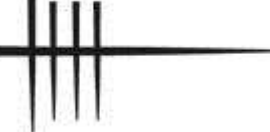

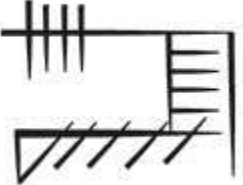
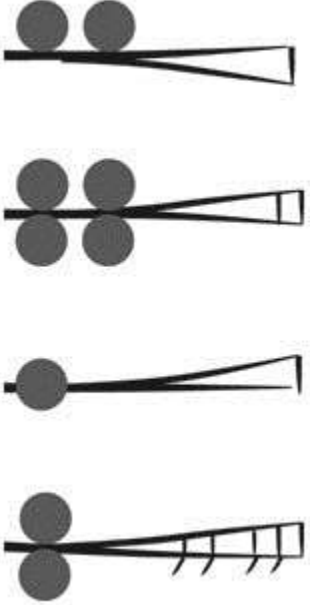
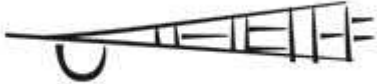
| Sign Name | Non-Numerical Sign Form |
|----------------------|---|
| NU_{11} |  |
| $NU_{11}-ten\hat{u}$ |  |
| $NU_{11}\&NU_{11}$ |  |
| $NUMUN$ |  |



| Sign Name | Non-Numerical Sign Form |
|-----------|---|
| NÚMUN |  |
| NUN |  |
| NUN+A |  |
| NUN+EN |  |



| Sign Name | Non-Numerical Sign Form |
|-----------|---|
| NUN+EN |  |
| NUN+EN |  |
| NUN+NĂM |  |
| NUN |  |

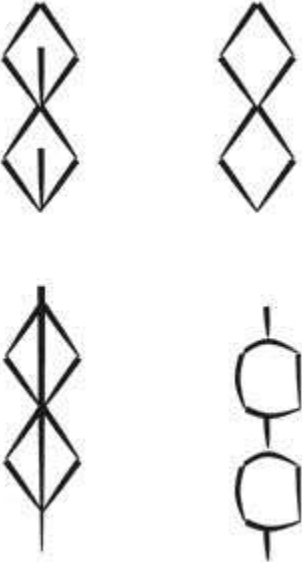

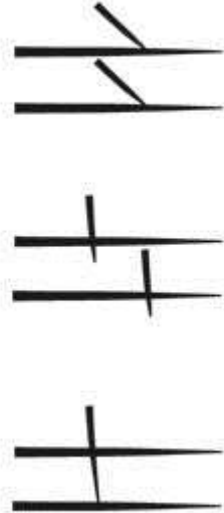
| Sign Name | Non-Numerical Sign Form |
|-----------|---|
| NUN+EN |  |
| NUN |  |
| NUN |  |

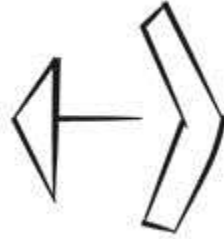

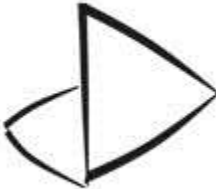
| Sign Name | Non-Numerical Sign Form |
|------------|--|
| NUNUZ |  |
| NUNUZ |  |
| NUNUZ-tenû |  |
| NUNUZ |  |



| Sign Name | Non-Numerical Sign Form |
|-----------|--|
| NUNUZ |  |
| NUNUZ |  |
| NUNUZ |  |

| Sign Name | Non-Numerical Sign Form |
|-----------|--|
| PA |  <p>The first variation consists of two horizontal lines with two diagonal strokes crossing them from top-right to bottom-left. The second variation consists of two horizontal lines with two vertical strokes crossing them. The third variation consists of two horizontal lines with one vertical stroke crossing them.</p> |
| PA |  <p>This variation consists of two horizontal lines with two diagonal strokes crossing them from top-left to bottom-right.</p> |
| PÀ |  <p>This variation consists of a left-pointing arrow and a right-pointing arrow connected by a horizontal line.</p> |

| Sign Name | Non-Numerical Sign Form |
|-----------|---|
| PAD |  |
| PAD |  |
| PAP |  |
| PAP-tenû |  |

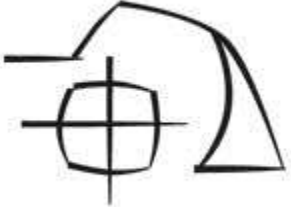
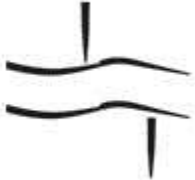

| Sign Name | Non-Numerical Sign Form |
|-----------|--|
| PAP |  |
| PIRIG |  |
| PIRIG |  |

| Sign Name | Non-Numerical Sign Form |
|-----------|--|
| PIRIG |  |
| PIRIG |  |
| PIRIG×ÚR |  |

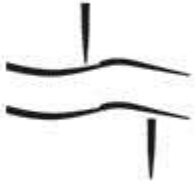
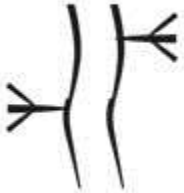
| Sign Name | Non-Numerical Sign Form |
|-----------|---|
| PIRIG |  |
| PÚ |  |
| RA |  |
| RAD |  |

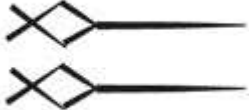
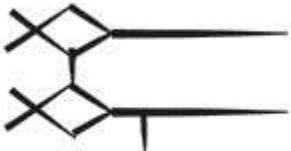
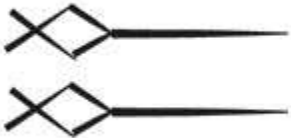
| Sign Name | Non-Numerical Sign Form |
|-----------|--|
| RAD-gunû |  |
| RAD-tenû |  |
| RAD |  |

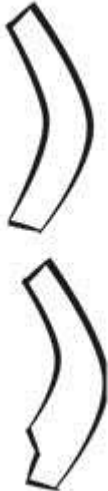
| Sign Name | Non-Numerical Sign Form |
|-----------------|---|
| RI |  |
| RI |  |
| RI ₈ |  |
| RI ₈ |  |

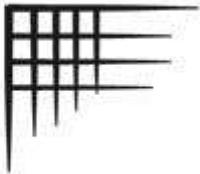

| Sign Name | Non-Numerical Sign Form |
|-----------|---|
| RU |  |
| RU-tenû |  |
| SA |  |



Sign Name

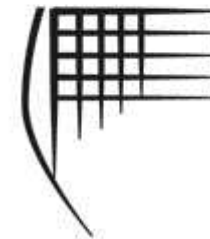

Non-Numerical Sign Form

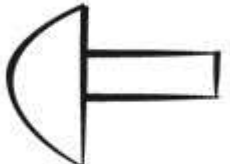
SA

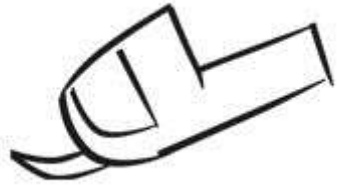

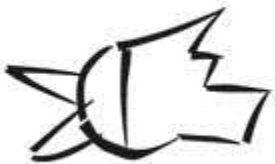

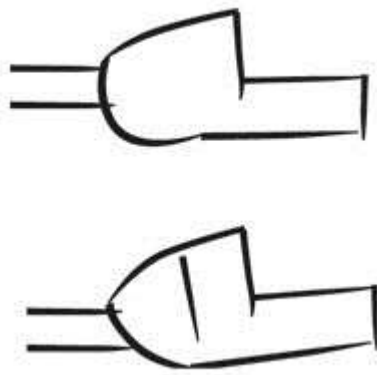

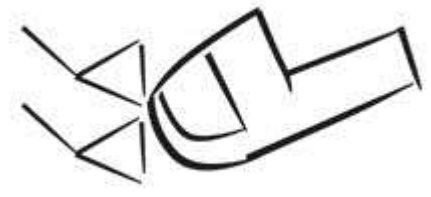
| Sign Name | Non-Numerical Sign Form |
|-------------|---|
| SAG |  |
| SAG-gunû |  |
| SAG-nutillû |  |

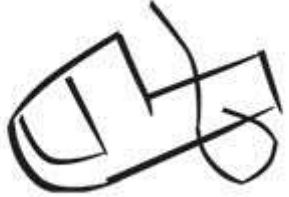
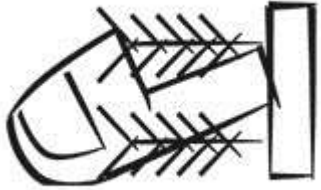
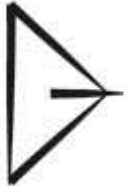
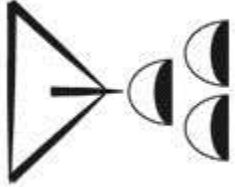
| Sign Name | Non-Numerical Sign Form |
|-----------|---|
| SAGŠU |  A line drawing of a hand with the index and middle fingers extended and slightly curved, representing the sign SAGŠU. |
| SAG×1 |  A line drawing of a hand with the index and middle fingers extended, and a solid black circle positioned below the middle finger, representing the sign SAG×1. |
| SAG×GEŠTU |  A line drawing of a hand with the index and middle fingers extended, and a jagged, lightning-bolt-like shape on the right side of the hand, representing the sign SAG×GEŠTU. |

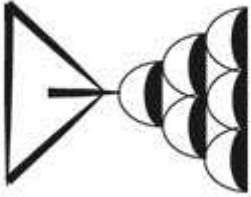
| Sign Name | Non-Numerical Sign Form |
|-----------|--|
| SAG×GEŠTU |  |
| SAG×GEŠTU |  |
| SAG×LAM |  |

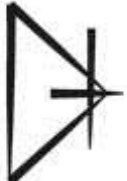

| Sign Name | Non-Numerical Sign Form |
|-----------|---|
| SAG×MA |  |
| SAG×SAR |  |
| SAL |  |
| SAL.KUR |  |

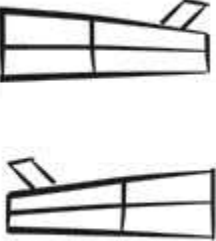

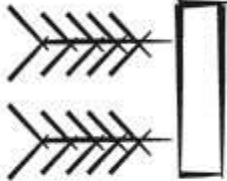
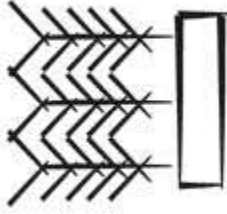
| Sign Name | Non-Numerical Sign Form |
|-----------|--|
| SAL.LAM |  |
| SAL.ŠÚ |  |
| SAL×1 |  |

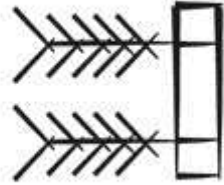
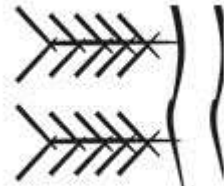
| Sign Name | Non-Numerical Sign Form |
|-----------|--|
| SANGA |  |
| SANGA |  |

| Sign Name | Non-Numerical Sign Form |
|-----------|--|
| SANGA |  |
| SAR |  |
| SAR × ŠE |  |

| Sign Name | Non-Numerical Sign Form |
|-----------|---|
| SAR |  |
| SAR |  |

| Sign Name | Non-Numerical Sign Form |
|--|--|
| <p data-bbox="682 488 755 532">SI</p> |  |
| <p data-bbox="669 984 768 1027">SI₄</p> |  |

| Sign Name | Non-Numerical Sign Form |
|-----------|---|
| SI_4 |  |
| SI_4 |  |

Sign Name



Non-Numerical Sign Form



SI₄



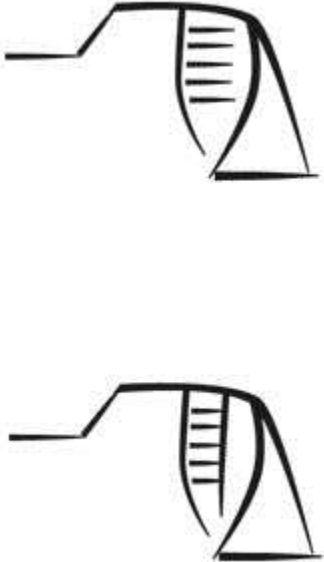



306





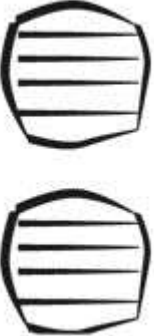

| Sign Name | Non-Numerical Sign Form |
|---|--|
| <p data-bbox="666 488 774 537">SI₄</p> |  |
| <p data-bbox="666 984 774 1032">SIG</p> |  |

| Sign Name | Non-Numerical Sign Form |
|-----------|---|
| SÍG |  |
| SÍG |  |

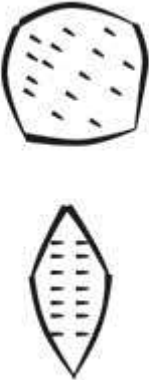

| Sign Name | Non-Numerical Sign Form |
|--|---|
| <p data-bbox="658 527 782 586">SÍG</p> |  |
| <p data-bbox="658 1057 782 1115">SÍG</p> |  |

| Sign Name | Non-Numerical Sign Form |
|-----------|--|
| SÍG |  |
| SÍG.SÍG |  |
| SÍG×1 |  |

| Sign Name | Non-Numerical Sign Form |
|-----------|---|
| SÍG |  |
| SÍG |  |
| SÍG |  |

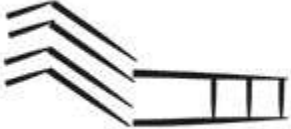
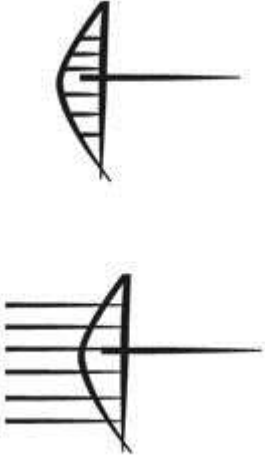

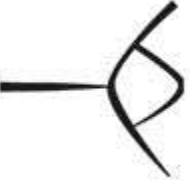
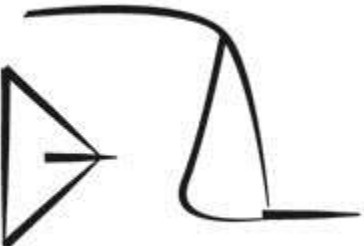
| Sign Name | Non-Numerical Sign Form |
|-----------|---|
| SÍG |  |
| SÍG |  |
| SÍG |  |

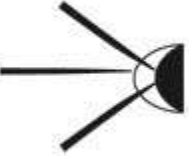

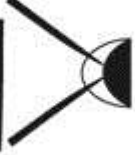
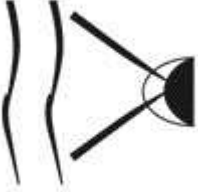
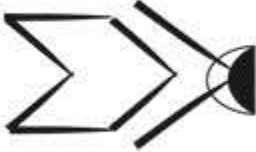
| Sign Name | Non-Numerical Sign Form |
|------------------|--|
| SIG |  |
| SIG ₄ |  |
| SIG ₇ |  |

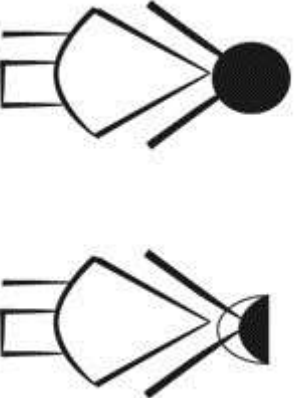
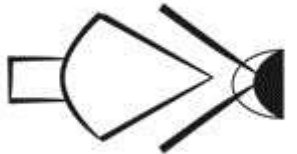
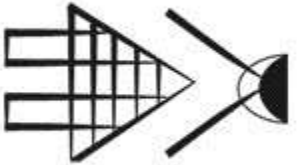
| Sign Name | Non-Numerical Sign Form |
|-----------|---|
| SIG×1 |  |
| SIKIL |  |
| SÌLA |  |
| SÌLA×1 |  |

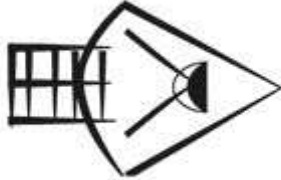
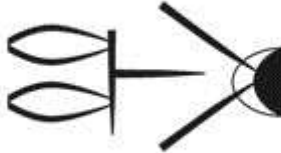

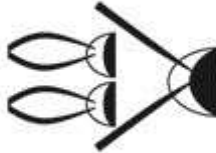
| Sign Name | Non-Numerical Sign Form |
|-----------|---|
| SÌLA×1 |  |
| SÌLA×A |  |
| SÌLA×AMAR |  |

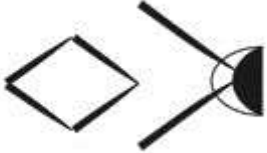
| Sign Name | Non-Numerical Sign Form |
|-----------|---|
| SÌLA×DUG |  |
| SÌLA×DUG |  |
| SÌLA×GA |  |

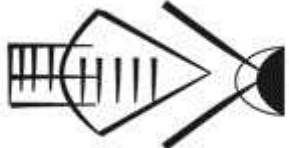
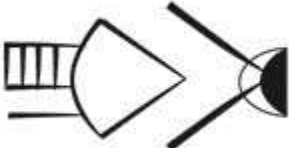
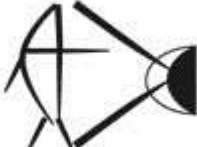

| Sign Name | Non-Numerical Sign Form |
|------------|---|
| SÌLA×GÁRA |  |
| SÌLA×GEŠTU |  |
| SÌLA×GEŠTU |  |
| SÌLA×GEŠTU |  |

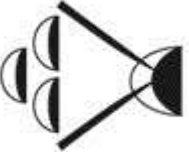

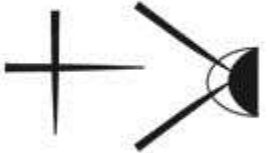
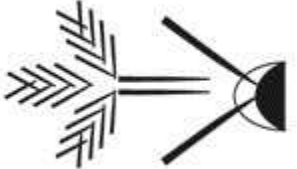
| Sign Name | Non-Numerical Sign Form |
|--------------|---|
| SÌLA×ĦAŠĦUR |  |
| SÌLA×ĦI |  |
| SÌLA×ĦI-gunû |  |
| SÌLA×IB |  |

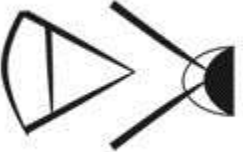
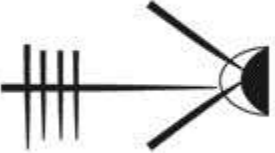
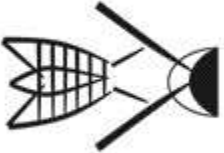
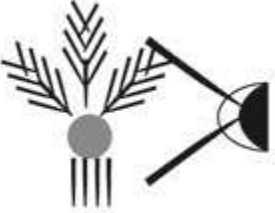

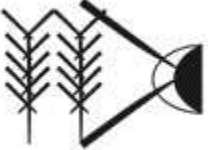
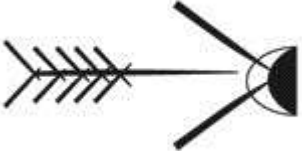
| Sign Name | Non-Numerical Sign Form |
|----------------------|---|
| SÌLA×KAŠ |  |
| SÌLA×KAŠ |  |
| SÌLA×KAŠ |  |
| SÌLA×KU ₆ |  |

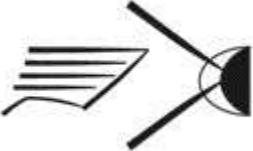

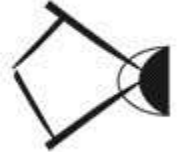
| Sign Name | Non-Numerical Sign Form |
|-----------|---|
| SÌLA×KUR |  |
| SÌLA×MA |  |
| SÌLA×MAŠ |  |
| SÌLA×NAGA |  |

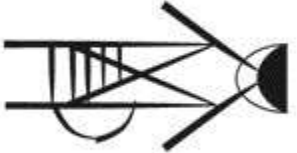
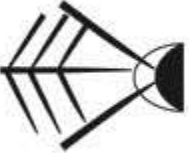

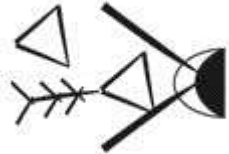
| Sign Name | Non-Numerical Sign Form |
|------------|---|
| SÌLA×NI |  |
| SÌLA×NUN |  |
| SÌLA×SUḪUR |  |
| SÌLA×SUM |  |

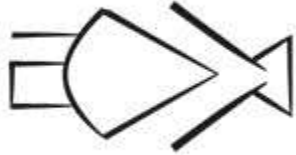
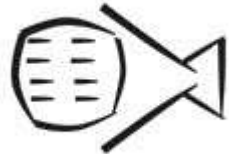

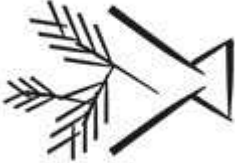
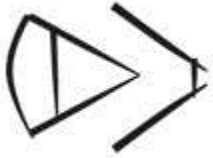
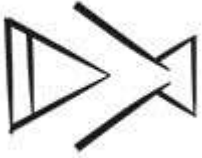
| Sign Name | Non-Numerical Sign Form |
|--------------|---|
| SÌLA×SUM |  |
| SÌLA×ŠE |  |
| SÌLA×ŠE-tenû |  |
| SÌLA×ŠU |  |

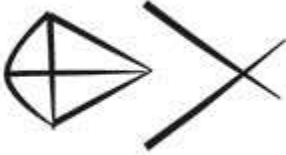

| Sign Name | Non-Numerical Sign Form |
|--------------|---|
| SÌLA×ŠÚ |  |
| SÌLA×X |  |
| SÌLA×ZATU629 |  |
| SÌLA×ZATU646 |  |

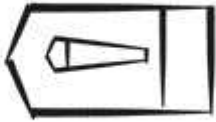

| Sign Name | Non-Numerical Sign Form |
|--------------------|---|
| SÌLA× (ZATU659.TU) |  |
| SÌLA |  |
| SÌLA×DUG |  |
| SÌLA×GÚG |  |

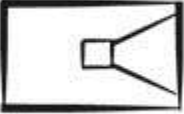
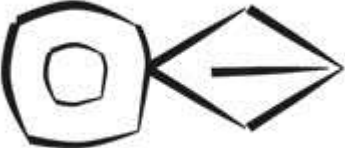

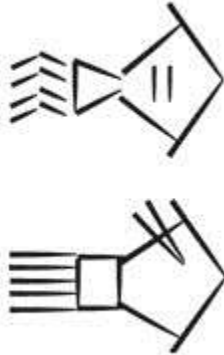

| Sign Name | Non-Numerical Sign Form |
|-----------|---|
| SÌLA×NAGA |  |
| SÌLA×NI |  |
| SÌLA×NI |  |
| SÌLA |  |

| Sign Name | Non-Numerical Sign Form |
|-------------------|---|
| SÌLA×ŠU |  |
| SÌLA×ZATU687 |  |
| SÌLA×NI |  |
| SILA ₄ |  |

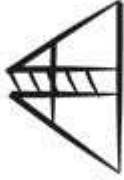

| Sign Name | Non-Numerical Sign Form |
|-------------------|---|
| SILA ₄ |  |
| SILA ₄ |  |
| SILA ₄ |  |
| SILANITA |  |



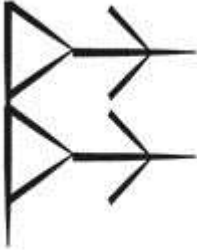
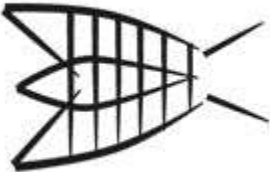
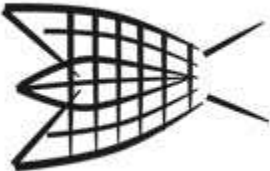
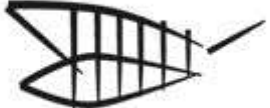

| Sign Name | Non-Numerical Sign Form |
|--------------------|--|
| SIMUG |  |
| SIPA |  |
| SI×GU ₄ |  |

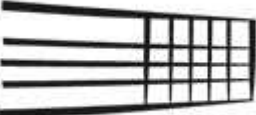
| Sign Name | Non-Numerical Sign Form |
|-----------|---|
| SI×ŠÉ |  |
| SU |  |
| SU×1 |  |

| Sign Name | Non-Numerical Sign Form |
|------------------|---|
| SU |  |
| SÙ |  |
| SUG |  |
| SUG ₅ |  |

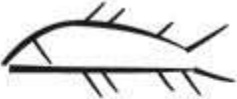

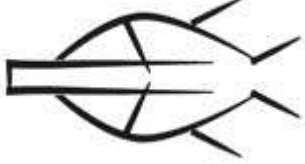
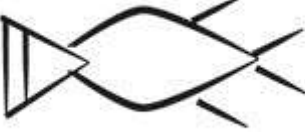
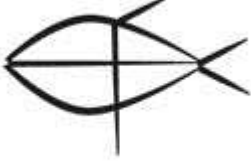

| Sign Name | Non-Numerical Sign Form |
|---------------|---|
| SÙḤ |  |
| SUḤUR |  |
| SUḤUR-gunû |  |
| SUḤUR-nutillû |  |

| Sign Name | Non-Numerical Sign Form |
|------------|---|
| SUKKAL |  |
| SUKUD |  |
| SUKUD-gunû |  |

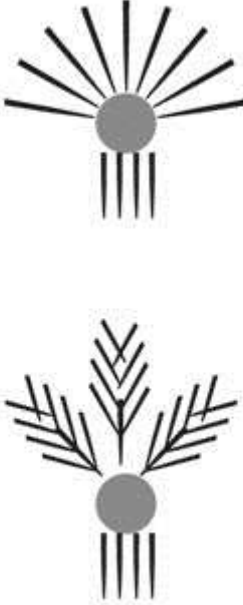
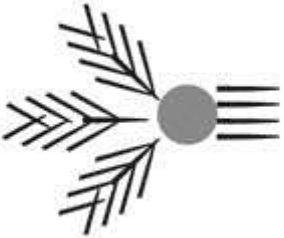



| Sign Name | Non-Numerical Sign Form |
|------------|--|
| SUKUD-gunû |   |
| SUKUD-gunû |  |
| SUKUD-gunû |  |

| Sign Name | Non-Numerical Sign Form |
|-------------|---|
| SUKUD+SUKUD |  |
| SUKUD+SUKUD |  |
| SUKUD+SUKUD |  |
| SUKUD+SUKUD |  |

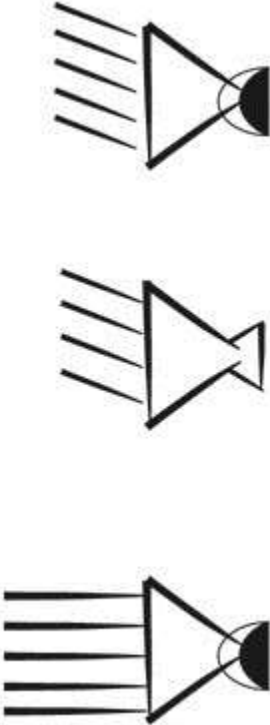
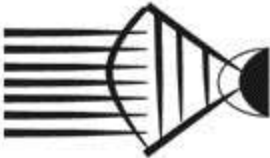
| Sign Name | Non-Numerical Sign Form |
|-----------|--|
| SUM |  |
| SUM-tenû |  |

| Sign Name | Non-Numerical Sign Form |
|-----------|---|
| SUM |  |
| SUMAŠ |  |
| SUR |  |
| SUSA |  |

| Sign Name | Non-Numerical Sign Form |
|--|---|
| <p data-bbox="682 558 755 613">ŠA</p> |  <p>The sign forms for 'ŠA' are arranged vertically. The top form consists of five slanted lines on the left and a triangle with a semi-circle on its right side. The middle form consists of four slanted lines on the left and a triangle with a semi-circle on its right side. The bottom form consists of five horizontal lines on the left and a triangle with a semi-circle on its right side.</p> |
| <p data-bbox="580 1127 854 1188">ŠA-gunû</p> |  <p>The sign form for 'ŠA-gunû' consists of five horizontal lines on the left and a triangle with a semi-circle on its right side.</p> |

| Sign Name | Non-Numerical Sign Form |
|-----------|---|
| ŠÀ |  |
| ŠÀ |  |
| ŠÀ |  |
| ŠÀ |  |

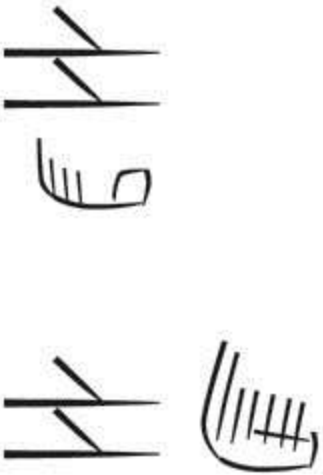
| Sign Name | Non-Numerical Sign Form |
|-----------|---|
| ŠÀ |  |
| ŠAB |  |



Sign Name

Non-Numerical Sign Form

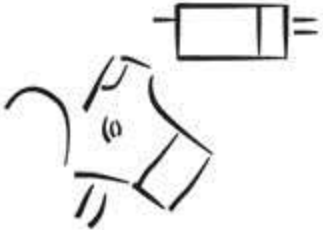

ŠAB



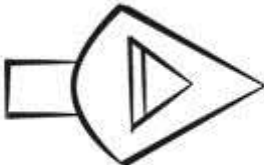

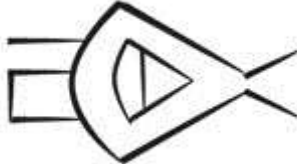
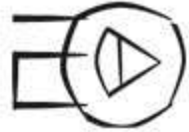
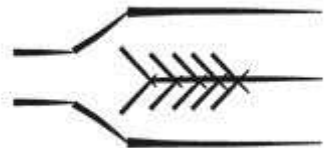
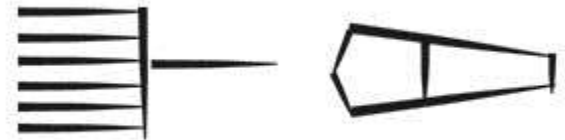

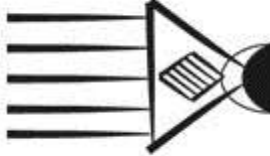
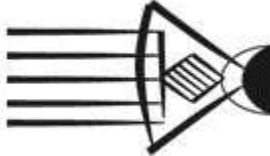
| Sign Name | Non-Numerical Sign Form |
|---|--|
| <p data-bbox="612 492 822 553">ŠAGAN</p> |  |
| <p data-bbox="599 1027 841 1089">ŠAGINA</p> |  |

| Sign Name | Non-Numerical Sign Form |
|-----------|---|
| ŠÁĤ |  |
| ŠÁĤ |  |
| ŠÁĤ |  |
| ŠAKIR |  |

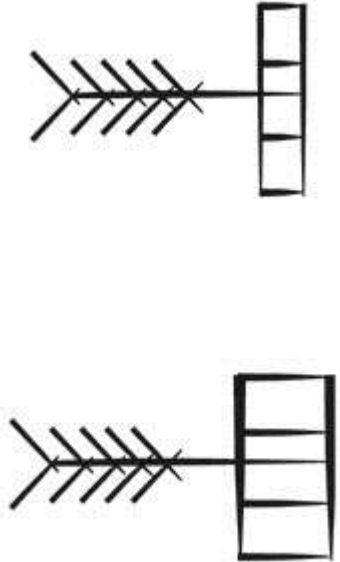
| Sign Name | Non-Numerical Sign Form |
|-----------|---|
| ŠAKIR |  |
| ŠAKIR |  |
| ŠÁM |  |
| ŠANDANA |  |

| Sign Name | Non-Numerical Sign Form |
|------------|---|
| ŠANDANA |  |
| ŠA×ḪI-gunû |  |
| ŠA×ḪI-gunû |  |
| ŠE.KÍN |  |

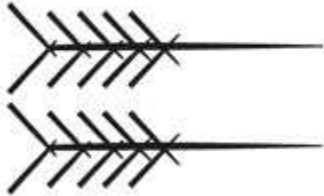
| Sign Name | Non-Numerical Sign Form |
|-----------------|--|
| <p>ŠE . NÁM</p> |  |
| <p>ŠE-tenû</p> |  |

| Sign Name | Non-Numerical Sign Form |
|-----------|---|
| ŠE & ŠE |  |
| ŠE |  |
| ŠE |  |

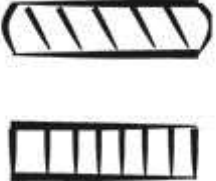
| Sign Name | Non-Numerical Sign Form |
|---|--|
| <p data-bbox="682 477 755 532">ŠÈ</p> |  |
| <p data-bbox="580 971 854 1026">ŠÈ-tenû</p> |  |

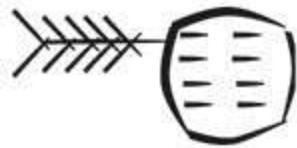

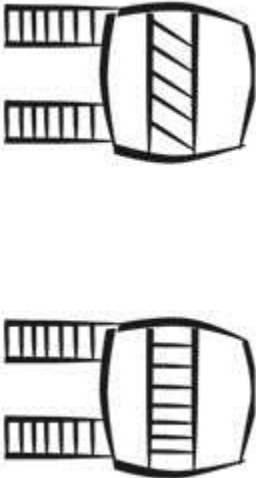
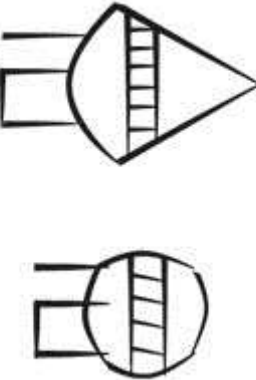
| Sign Name | Non-Numerical Sign Form |
|------------------|---|
| ŠEG ₉ |  |
| ŠELU |  |

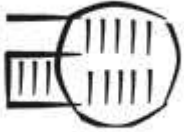
| Sign Name | Non-Numerical Sign Form |
|---|--|
| <p data-bbox="658 435 782 493">ŠEN</p> |  |
| <p data-bbox="658 987 782 1045">ŠEN</p> |  |

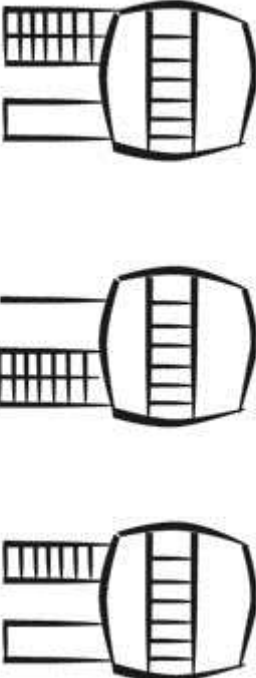
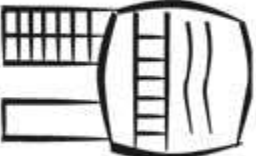
| Sign Name | Non-Numerical Sign Form |
|-----------|---|
| ŠEN |  |
| ŠEN-tenû |  |

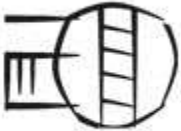
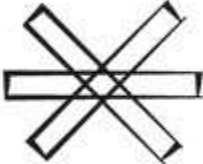
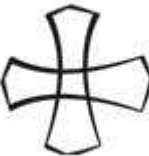
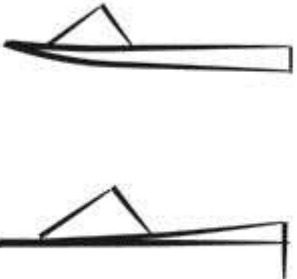

| Sign Name | Non-Numerical Sign Form |
|--|---|
| <p data-bbox="658 535 779 592">ŠEN</p> |  |
| <p data-bbox="618 1088 819 1144">ŠEN×A</p> |  |



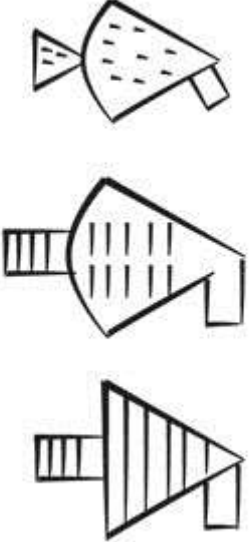
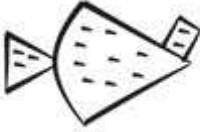

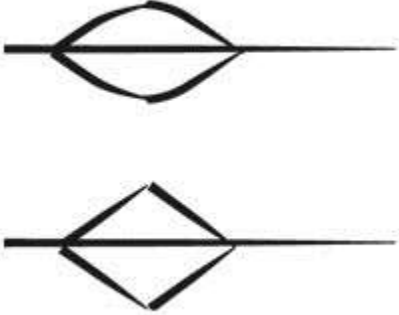
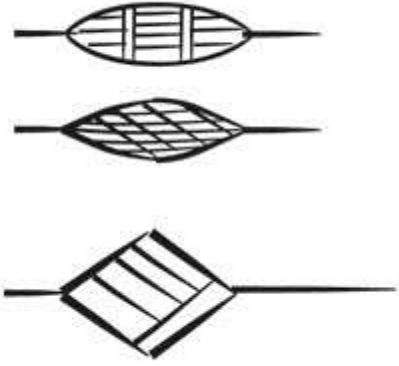
| Sign Name | Non-Numerical Sign Form |
|-----------|---|
| ŠEN |  |
| ŠENNUR |  |
| ŠENNUR |  |
| ŠEŠ |  |



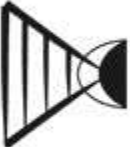

| Sign Name | Non-Numerical Sign Form |
|------------|---|
| ŠEŠ |  |
| ŠIDIM |  |
| ŠIDIM-tenû |  |





| Sign Name | Non-Numerical Sign Form |
|--|--|
| <p data-bbox="658 472 782 529">ŠIM</p> |  |
| <p data-bbox="658 935 782 992">ŠIM</p> |  |





| Sign Name | Non-Numerical Sign Form |
|-----------|--|
| ŠIR |  |
| ŠIR |  |



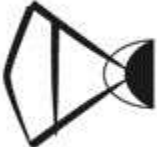

| Sign Name | Non-Numerical Sign Form |
|--------------------|--|
| <p>ŠITA-gunû</p> |  |
| <p>ŠITA-gunû×1</p> |  |
| <p>ŠITA-gunû×1</p> |  |

| Sign Name | Non-Numerical Sign Form |
|-----------|---|
| ŠITA-gunû |  |
| ŠITA |  |
| ŠITA×1 |  |
| ŠITA×KAK |  |



| Sign Name | Non-Numerical Sign Form |
|-----------|---|
| ŠITA×ŠU |  |
| ŠITA×ŠÚ |  |
| ŠITA×UDU |  |
| ŠITA |  |



| Sign Name | Non-Numerical Sign Form |
|--------------|---|
| ŠITA |  |
| ŠITA |  |
| ŠITA×ĦI-gunû |  |
| ŠITA |  |

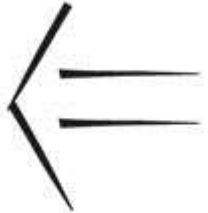
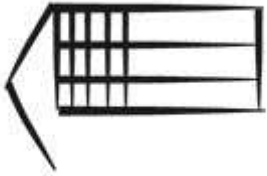

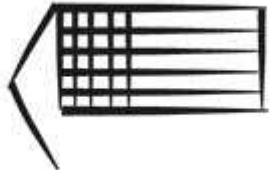
| Sign Name | Non-Numerical Sign Form |
|-----------|---|
| ŠITA |  |
| ŠITA×NÁM |  |
| ŠITA |  |
| ŠU |  |

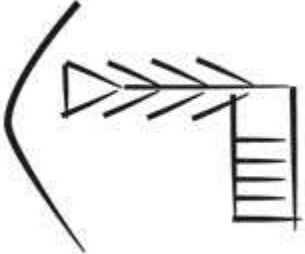
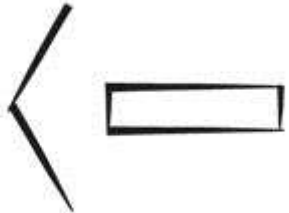

| Sign Name | Non-Numerical Sign Form |
|------------------|---|
| ŠU-gunû |  |
| ŠU-šeššig |  |
| ŠU&ŠU |  |
| ŠU ₁₂ |  |



| Sign Name | Non-Numerical Sign Form |
|-----------|--|
| ŠÚ.1 |  |
| ŠÚ.2 |  |
| ŠÚ.É |  |

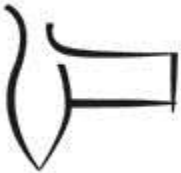

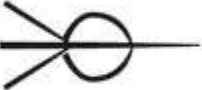
| Sign Name | Non-Numerical Sign Form |
|-----------|--|
| ŠÚ.É |  |
| ŠÚ.EN |  |

| Sign Name | Non-Numerical Sign Form |
|-------------------------|--|
| ŠÚ.EN |  |
| ŠÚ.GIŠ |  |
| ŠÚ. ((ĤI×1) & (ĤI×1)) |  |



| Sign Name | Non-Numerical Sign Form |
|-----------|---|
| ŠÚ |  |
| ŠÚ. ÌRI |  |
| ŠUBUR |  |

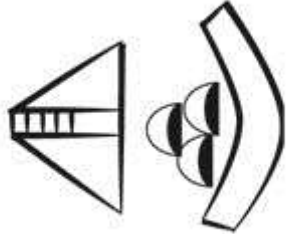

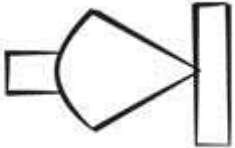
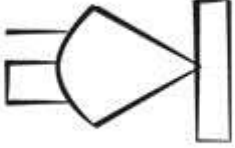
| Sign Name | Non-Numerical Sign Form |
|-----------|---|
| ŠUM |  |
| ŠÚR |  |
| ŠÚR |  |

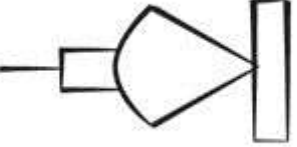
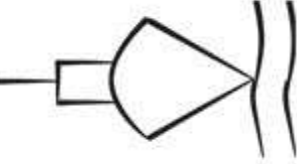
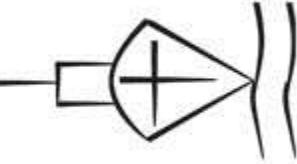
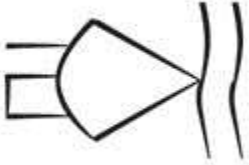

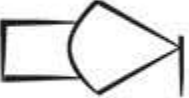
| Sign Name | Non-Numerical Sign Form |
|-----------------|--|
| <p>ŠURUPPAK</p> |  |
| <p>ŠURUPPAK</p> |  |

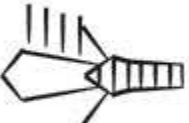
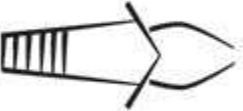

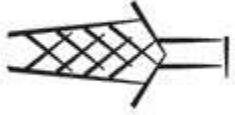
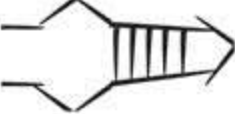
| Sign Name | Non-Numerical Sign Form |
|-----------|---|
| ŠURUPPAK |  |
| ŠU×1 |  |
| TA |  |
| TA |  |

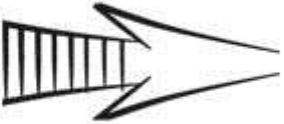
| Sign Name | Non-Numerical Sign Form |
|-----------|---|
| TA |  |
| TA |  |
| TA×MAŠ |  |
| TA |  |

| Sign Name | Non-Numerical Sign Form |
|-----------|---|
| TA |  |
| TAG |  |
| TAG-tenû |  |
| TAG |  |
| TAG |  |



| Sign Name | Non-Numerical Sign Form |
|-----------|--|
| TAG |  |
| TAG |  |
| TAG |  |
| TAG |  |

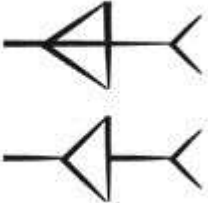

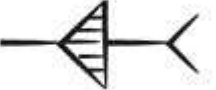
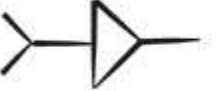
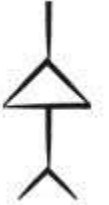
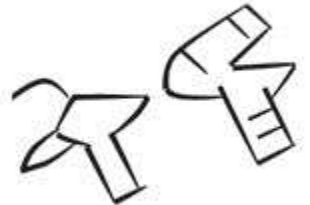
| Sign Name | Non-Numerical Sign Form |
|---------------------------|---|
| TAK ₄ |  |
| TAK ₄ -nutillû |  |
| TAK ₄ |  |

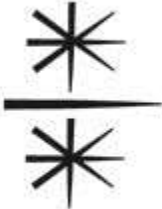
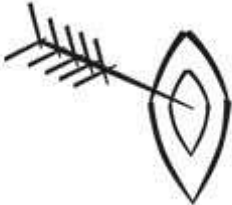
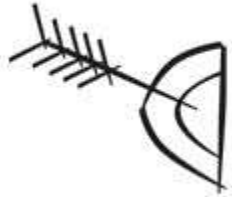

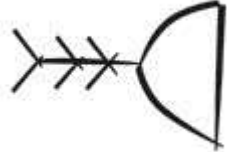
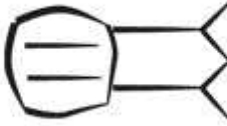

| Sign Name | Non-Numerical Sign Form |
|-----------|--|
| TAR |  |
| TAR |  |
| TE |  |
| TI |  |



| Sign Name | Non-Numerical Sign Form |
|-------------------------|--|
| TI-gunû |  |
| TI-vertically reflected |  |
| TI-tenû |  |
| TIDNUM |  |

| Sign Name | Non-Numerical Sign Form |
|-----------|--|
| TÍLLA |  |
| TU |  |
| TU |  |

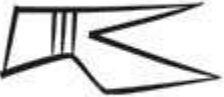

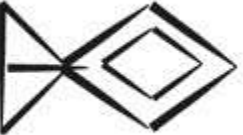
| Sign Name | Non-Numerical Sign Form |
|----------------|---|
| TU |  |
| TÚG. (BAD&BAD) |  |
| TÚG |  |

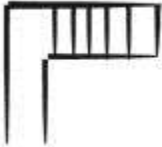
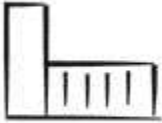
| Sign Name | Non-Numerical Sign Form |
|-----------|---|
| TÚG-gunû |  |
| TÚG |  |
| TÚG |  |

| Sign Name | Non-Numerical Sign Form |
|-----------|---|
| TÚG |  |
| TUM |  |
| TUM-gunû |  |
| TUM |  |
| TUM |  |

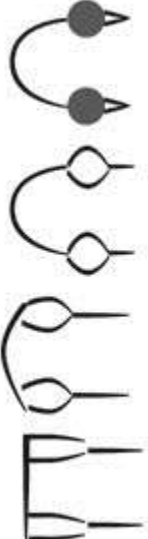
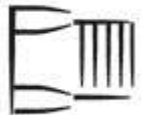
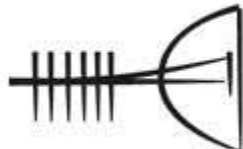

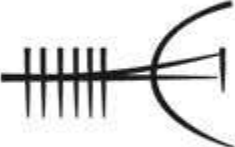
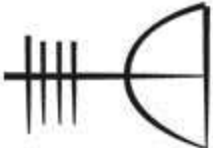

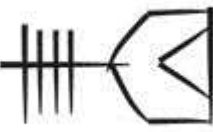
| Sign Name | Non-Numerical Sign Form |
|-----------|--|
| TUM |  |
| TÙN |  |
| TÙN |  |
| TÙN |  |

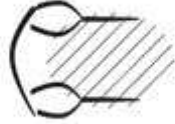
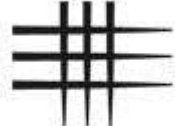

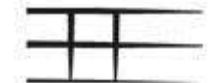

| Sign Name | Non-Numerical Sign Form |
|-----------|---|
| TUR |  |
| TUR-gunû |  |
| TÙR |  |



| Sign Name | Non-Numerical Sign Form |
|----------------------|---|
| TÙR-nutillû |  |
| TÙR |  |
| TÙR×TAK ₄ |  |
| TÙR |  |

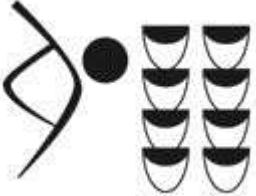



| Sign Name | Non-Numerical Sign Form |
|-----------|---|
| TUR×X |  A hand sign where the palm is facing left, fingers are curled, and the thumb is extended downwards. The back of the hand is shaded with diagonal lines. |
| Ú |  A hand sign consisting of three horizontal lines and three vertical lines, forming a grid pattern. |

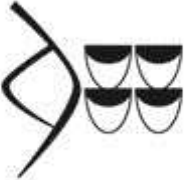



| Sign Name | Non-Numerical Sign Form |
|-----------|---|
| <p>ú</p> |  |
| <p>ú</p> |  |





| Sign Name | Non-Numerical Sign Form |
|---------------------|---|
| U ₄ .1 |  |
| U ₄ .1.3 |  |
| U ₄ .1.4 |  |
| U ₄ .1.5 |  |



| Sign Name | Non-Numerical Sign Form |
|---------------------|---|
| U ₄ .1.8 |  |
| U ₄ .1 |  |
| U ₄ .2 |  |
| U ₄ .2 |  |





| Sign Name | Non-Numerical Sign Form |
|--------------------|---|
| U ₄ . 3 |  |
| U ₄ . 4 |  |
| U ₄ . 5 |  |
| U ₄ . 6 |  |

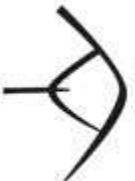

| Sign Name | Non-Numerical Sign Form |
|---------------------|---|
| U ₄ . 7 |  |
| U ₄ . 8 |  |
| U ₄ |  |
| U ₄ . ŠÚ |  |





| Sign Name | Non-Numerical Sign Form |
|----------------------|---|
| U ₄ -tenû |  |
| U ₄ ×10 |  |
| U ₄ ×1.5 |  |
| U ₄ ×1 |  |

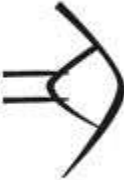

| Sign Name | Non-Numerical Sign Form |
|----------------------------|---|
| $U_4 \times 1\text{-flat}$ |  |
| $U_4 \times (1.2)$ |  |
| $U_4 \times (1.4)$ |  |
| $U_4 \times (1.8)$ |  |





| Sign Name | Non-Numerical Sign Form |
|------------------------|---|
| U ₄ ×1 |  |
| U ₄ ×1 |  |
| U ₄ ×1-tenû |  |
| U ₄ ×2.2.1 |  |





| Sign Name | Non-Numerical Sign Form |
|--------------------|---|
| $U_4 \times 2.2$ |  |
| $U_4 \times 2$ |  |
| $U_4 \times 2.X$ |  |
| $U_4 \times (2.4)$ |  |



| Sign Name | Non-Numerical Sign Form |
|--------------------|---|
| $U_4 \times 2$ |  |
| $U_4 \times 2$ |  |
| $U_4 \times 3 . 3$ |  |
| $U_4 \times 3$ |  |



| Sign Name | Non-Numerical Sign Form |
|--------------------|---|
| $U_4 \times (3.2)$ |  |
| $U_4 \times (3.7)$ |  |
| $U_4 \times 3$ |  |
| $U_4 \times 4.2$ |  |

| Sign Name | Non-Numerical Sign Form |
|------------------|--|
| $U_4 \times 4$ |  |
| $U_4 \times 4$ |  |
| $U_4 \times 5.1$ |  |



| Sign Name | Non-Numerical Sign Form |
|----------------|---|
| $U_4 \times 5$ |  |
| $U_4 \times 5$ |  |
| $U_4 \times 6$ |  |
| $U_4 \times 6$ |  |

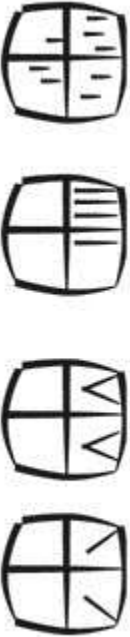

| Sign Name | Non-Numerical Sign Form |
|--------------------|---|
| $U_4 \times 7$ |  |
| $U_4 \times 8$ |  |
| $U_4 \times 8 . X$ |  |
| $U_4 \times 8$ |  |

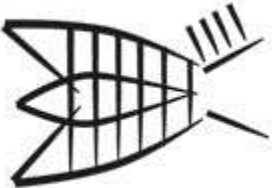
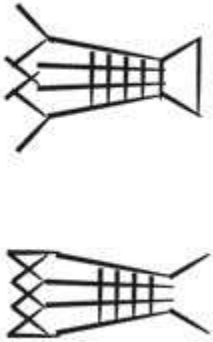
| Sign Name | Non-Numerical Sign Form |
|--------------------|--|
| $U_4 \times X$ |  |
| $U_4 \times (X+2)$ |  |
| $U_4 \times X$ |  |

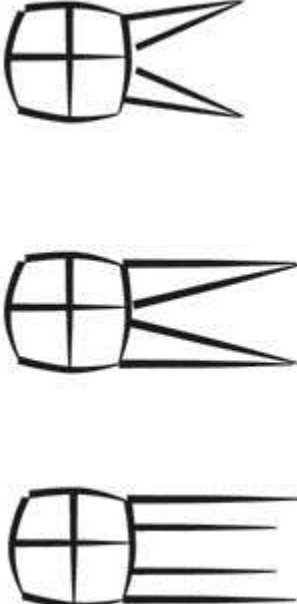
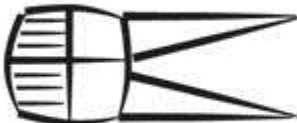

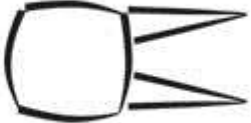

| Sign Name | Non-Numerical Sign Form |
|------------------|--|
| U_8 |  |
| $U_8 \times TAR$ |  |

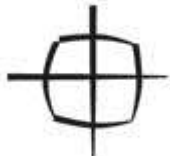
| Sign Name | Non-Numerical Sign Form |
|-----------|--|
| UB |  |
| UBI |  |
| UBI |  |

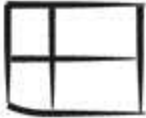
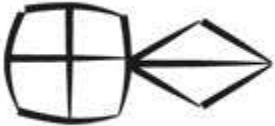
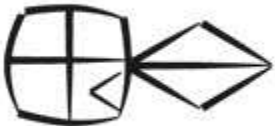
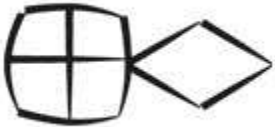

| Sign Name | Non-Numerical Sign Form |
|-----------------------|---|
| UD ₅ |  |
| UD ₅ -gunû |  |
| UD ₅ |  |



| Sign Name | Non-Numerical Sign Form |
|-----------------|--|
| UD ₅ |  |
| UDU |  |
| UDU×TAR |  |
| UDU×TAR |  |

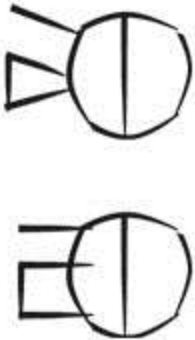
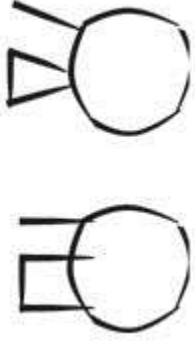

| Sign Name | Non-Numerical Sign Form |
|-----------|---|
| UDU |  |
| UDU |  |
| UDUNITA |  |
| UDUNITA |  |
| UDUNITA |  |

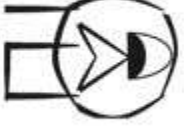

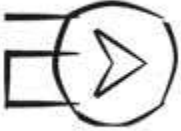
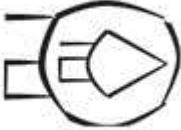
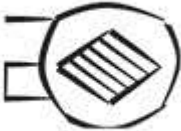
| Sign Name | Non-Numerical Sign Form |
|-----------|---|
| UET2.405 |  |
| UḤ |  |
| ÙḤ |  |
| ÙḤ-tenû |  |

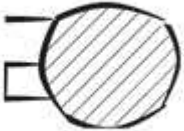

| Sign Name | Non-Numerical Sign Form |
|--------------|---|
| <p>ÙḤ</p> |  |
| <p>UKKIN</p> |  |
| <p>UKKIN</p> |  |

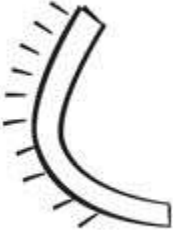

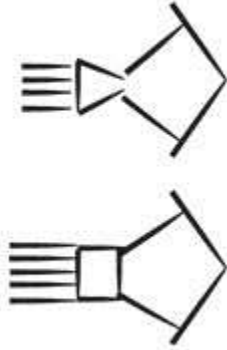

| Sign Name | Non-Numerical Sign Form |
|----------------|---|
| UKKIN×2 |  |
| UKKIN×3 |  |
| UKKIN×5 |  |
| UKKIN× (DIN.1) |  |

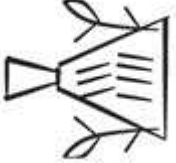

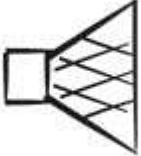

| Sign Name | Non-Numerical Sign Form |
|---------------|---|
| UKKIN×DIN |  |
| UKKIN×DUG |  |
| UKKIN×ĤI-gunû |  |
| UKKIN×NI |  |



| Sign Name | Non-Numerical Sign Form |
|-----------|---|
| UKKIN×X |  |
| UKKIN |  |
| UMBIN |  |
| UMBIN |  |



| Sign Name | Non-Numerical Sign Form |
|-----------|--|
| UMB IN |  |
| UMB IN |  |
| ÚMUN |  |



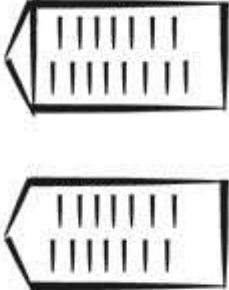
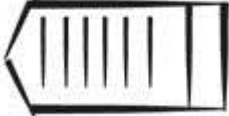

| Sign Name | Non-Numerical Sign Form |
|-------------|--|
| UNUG |  |
| UNUG-šeššig |  |
| UNUGxA-tenû |  |

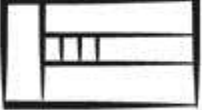
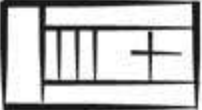
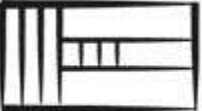
| Sign Name | Non-Numerical Sign Form |
|-----------|--|
| UNUG |  |
| UNUG |  |
| UR |  |
| UR-gunû |  |



| Sign Name | Non-Numerical Sign Form |
|-----------|---|
| UR×KÁR |  |
| UR |  |
| UR |  |
| ÚR |  |
| ÚR×1 |  |

| Sign Name | Non-Numerical Sign Form |
|-----------|---|
| ÚR×TAR |  |
| ÙR |  |
| ÙR |  |
| ÙR |  |

| Sign Name | Non-Numerical Sign Form |
|---|--|
| <p style="text-align: center;">ÙR</p> |  |
| <p style="text-align: center;">ÙR×MAŠ</p> |  |
| <p style="text-align: center;">ÙR</p> |  |
| <p style="text-align: center;">UR₄</p> |  |

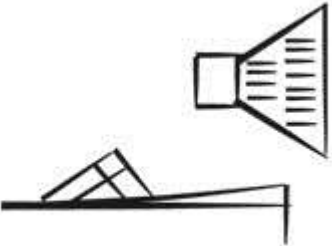
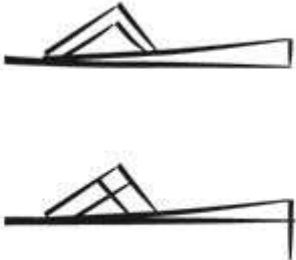

| Sign Name | Non-Numerical Sign Form |
|-----------------|---|
| UR ₄ |  |
| UR ₄ |  |
| UR ₅ |  |
| UR ₅ |  |

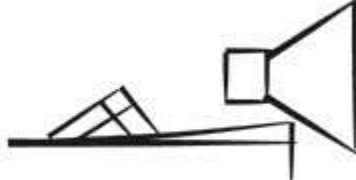
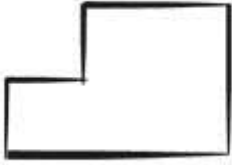

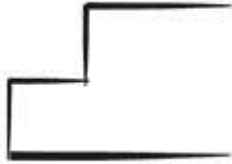
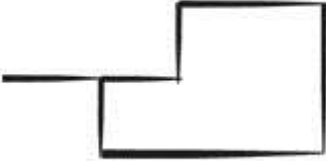
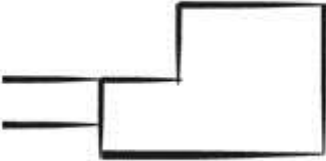
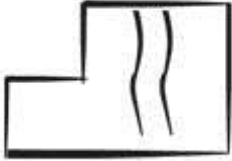
| Sign Name | Non-Numerical Sign Form |
|-----------|--|
| URI |  |
| ÚRI |  |
| ÛRI |  |

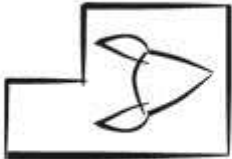
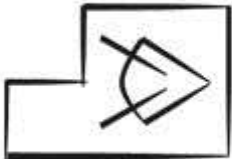
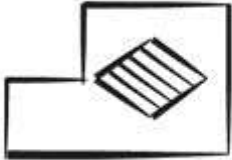
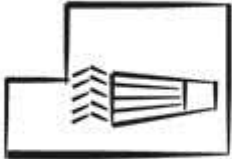
| Sign Name | Non-Numerical Sign Form |
|------------------|---|
| ÙRI+IB |  |
| ÙRI |  |
| URI ₅ |  |
| URU |  |

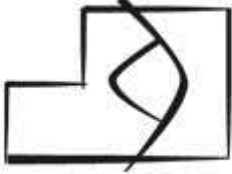
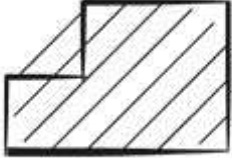
| Sign Name | Non-Numerical Sign Form |
|-------------|---|
| URU-nutillû |  |
| URU×1 |  |
| URU×2 |  |
| URU×A |  |

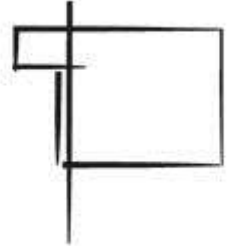
| Sign Name | Non-Numerical Sign Form |
|---------------------|---|
| URU×AMAR |  |
| URU×GU ₄ |  |
| URU×ĜI-gunû |  |
| URU×NIMGIR |  |

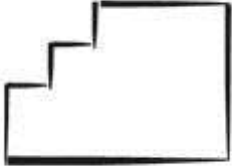

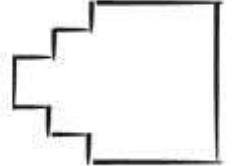
| Sign Name | Non-Numerical Sign Form |
|--------------------|---|
| URU×U ₄ |  |
| URU×X |  |
| URU |  |
| URU×1 |  |

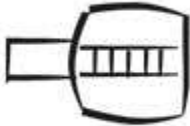
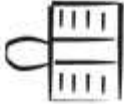
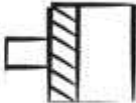
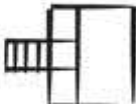
| Sign Name | Non-Numerical Sign Form |
|-----------|---|
| URU×KALAM |  |
| URU |  |
| URU |  |
| URU |  |

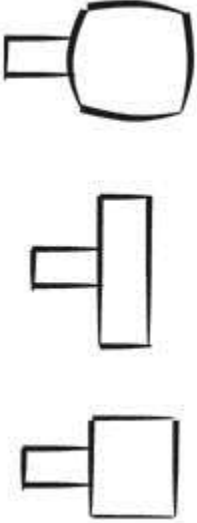
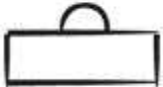
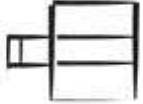
| Sign Name | Non-Numerical Sign Form |
|------------|--|
| URUDU-gunû |  |
| URUDU-gunû |  |
| URUDU-gunû |  |
| URUDU-gunû |  |

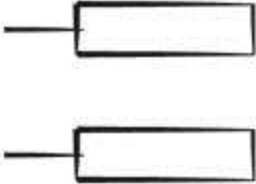
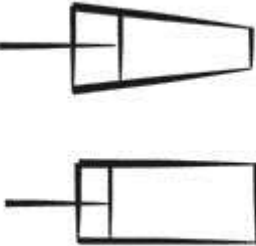
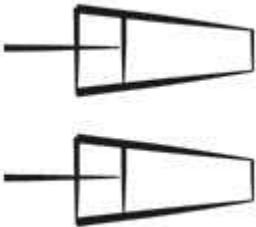
| Sign Name | Non-Numerical Sign Form |
|-----------|---|
| URUDU |  |
| URUDU |  |
| URUDU |  |

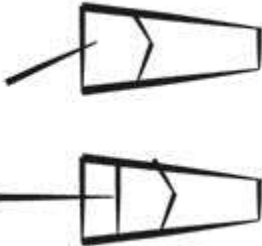
| Sign Name | Non-Numerical Sign Form |
|-----------|---|
| UŠ |  |
| UŠ & UŠ |  |
| UŠ |  |
| UŠ & UŠ |  |

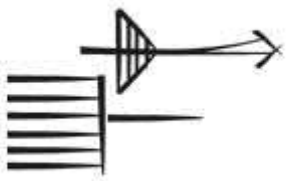
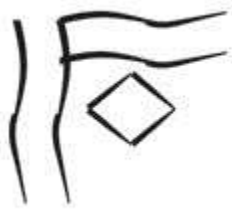

| Sign Name | Non-Numerical Sign Form |
|-----------|---|
| UŠ×TAR |  |
| UŠ×TAR |  |
| UŠUMGAL |  |
| UŠUR |  |

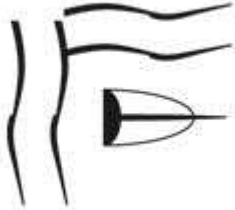
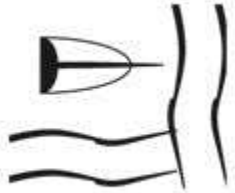
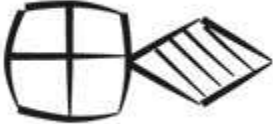

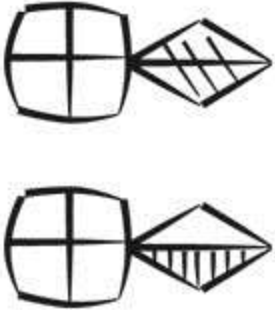
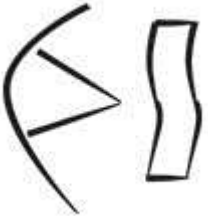

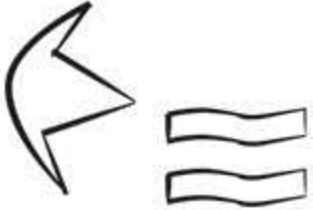
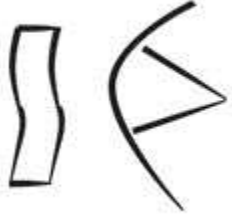

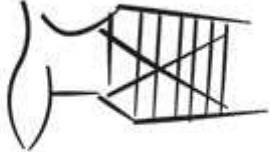
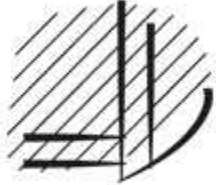
| Sign Name | Non-Numerical Sign Form |
|---|--|
| <p data-bbox="639 300 801 365">ÙŠUR</p> |  |
| <p data-bbox="639 625 801 690">ÙŠUR</p> |  |
| <p data-bbox="639 917 801 982">UTUA</p> |  |

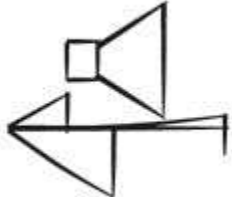
| Sign Name | Non-Numerical Sign Form |
|-----------|---|
| UTUA-tenû |  |
| UTUA |  |
| UTUL |  |

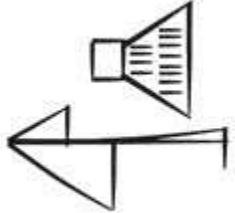
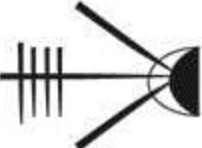
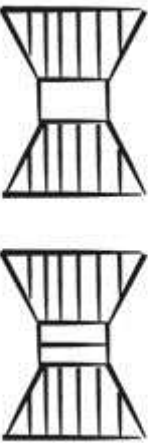
| Sign Name | Non-Numerical Sign Form |
|-----------|--|
| UTUL |  |
| UTUL |  |
| UTUL |  |



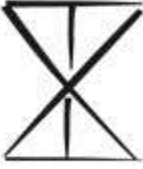

| Sign Name | Non-Numerical Sign Form |
|-----------|---|
| UZU |  |
| X.GAR |  |
| ZA |  |
| ZABALAM |  |

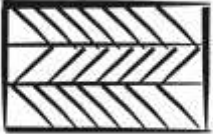
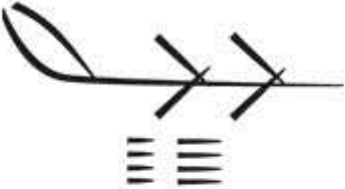
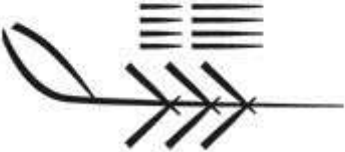
| Sign Name | Non-Numerical Sign Form |
|-----------|--|
| ZABALAM |  |
| ZADIM |  |
| ZAG |  |

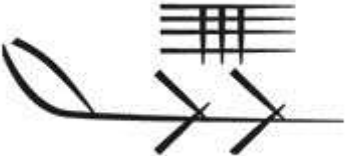
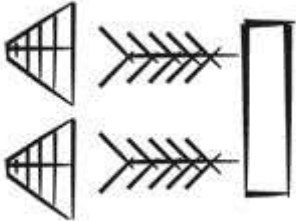
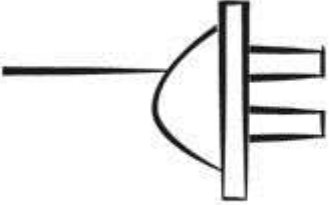
| Sign Name | Non-Numerical Sign Form |
|-----------|---|
| ZAG |  |
| ZAG |  |
| ZAR |  |
| ZAR |  |



| Sign Name | Non-Numerical Sign Form |
|-----------|--|
| ZAR |  |
| ZAR |  |
| ZI |   |

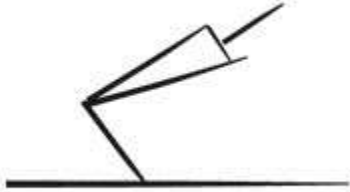
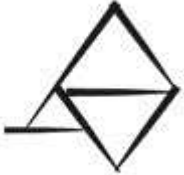

| Sign Name | Non-Numerical Sign Form |
|---------------|---|
| ZI |  |
| ZI |  |
| (ZU&ZU) . SAR |  |
| ZUBI |  |

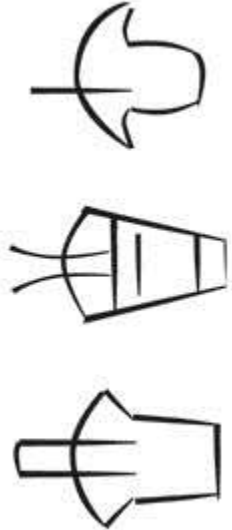
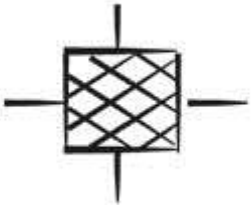

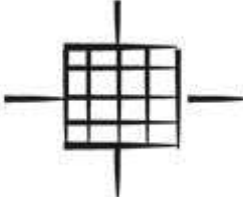
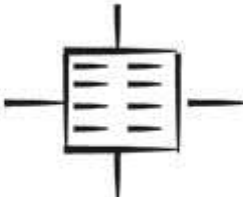
| Sign Name | Non-Numerical Sign Form |
|-----------|--|
| ZUBI |  |
| ZATU620 |  |
| ZATU621 |  |
| ZATU621 |  |

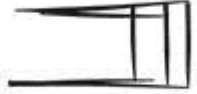

| Sign Name | Non-Numerical Sign Form |
|-----------|--|
| ZATU621 |  |
| ZATU621 |  |
| ZATU622 |  |

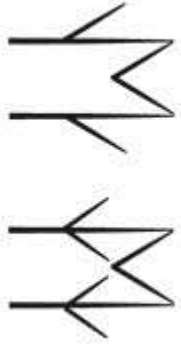

| Sign Name | Non-Numerical Sign Form |
|-----------|--|
| ZATU623 |  |
| ZATU624 |  |

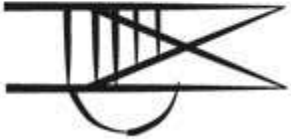
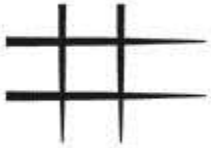

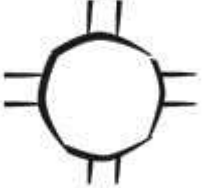
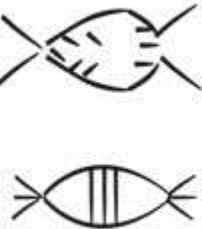

| Sign Name | Non-Numerical Sign Form |
|-----------|---|
| ZATU624 |  |
| ZATU624 |  |
| ZATU625 |  |
| ZATU626 |  |

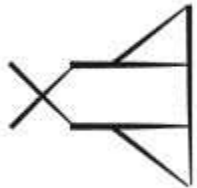

| Sign Name | Non-Numerical Sign Form |
|-----------|---|
| ZATU626 |  |
| ZATU626 |  |
| ZATU627 |  |
| ZATU628 |  |



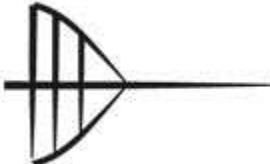
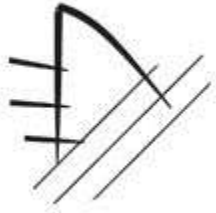

| Sign Name | Non-Numerical Sign Form |
|-----------|--|
| ZATU628 |  |
| ZATU629 |   |
| ZATU630 |  |

| Sign Name | Non-Numerical Sign Form |
|-----------|--|
| ZATU631 |  |
| ZATU632 |  |
| ZATU632 |  |

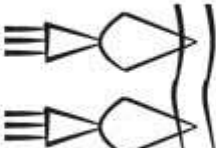

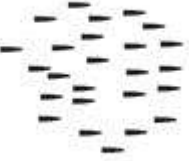
| Sign Name | Non-Numerical Sign Form |
|-----------|---|
| ZATU632 |  |
| ZATU633 |  |
| ZATU633 |  |
| ZATU634 |  |

| Sign Name | Non-Numerical Sign Form |
|-----------|--|
| ZATU635 |  |
| ZATU636 |   |
| ZATU637 |  |

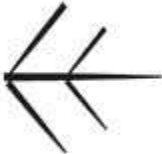
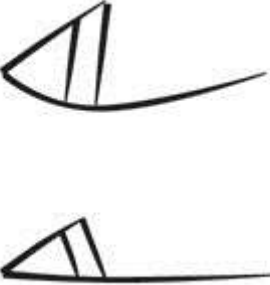
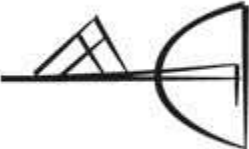

| Sign Name | Non-Numerical Sign Form |
|-----------|---|
| ZATU639 |  |
| ZATU640 |  |
| ZATU641 |  |
| ZATU642 |  |

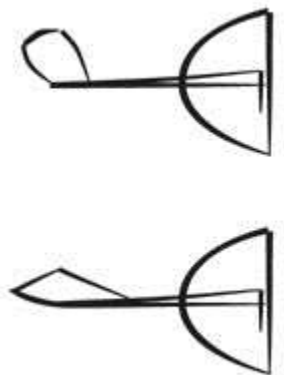
| Sign Name | Non-Numerical Sign Form |
|-----------|---|
| ZATU643 |  |
| ZATU644 |  |
| ZATU644×1 |  |
| ZATU644 |  |



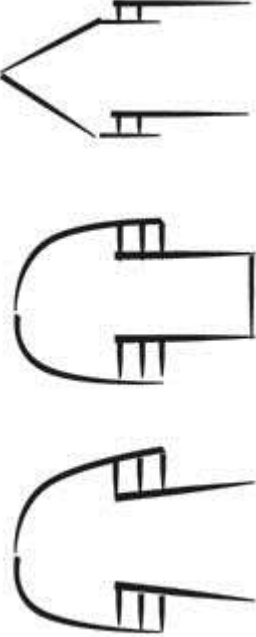
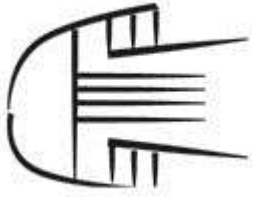

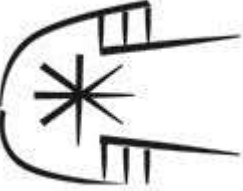
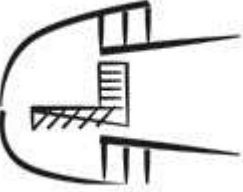
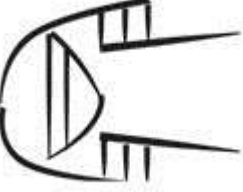
| Sign Name | Non-Numerical Sign Form |
|-----------|--|
| ZATU646 |  |
| ZATU647 |  |
| ZATU648 |  |

| Sign Name | Non-Numerical Sign Form |
|-----------|---|
| ZATU649 |  |
| ZATU650 |  |

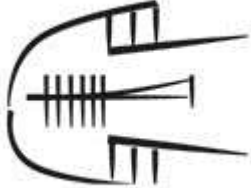
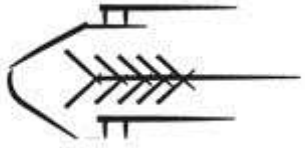
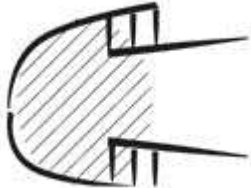
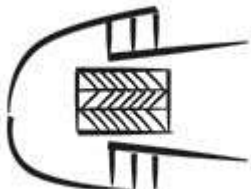
| Sign Name | Non-Numerical Sign Form |
|--------------|--|
| ZATU651 |  |
| ZATU651-gunû |  |

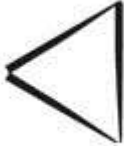

| Sign Name | Non-Numerical Sign Form |
|-------------|---|
| ZATU651×AN |  |
| ZATU651×EN |  |
| ZATU651×GAR |  |
| ZATU651×MA |  |

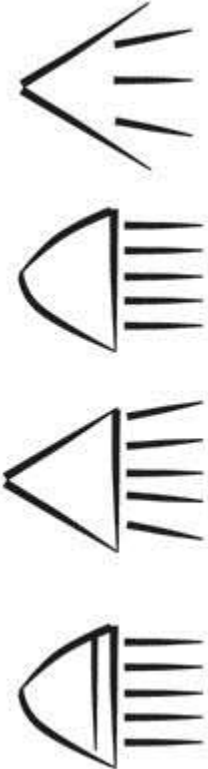

| Sign Name | Non-Numerical Sign Form |
|-------------|---|
| ZATU651×NUN |  |
| ZATU651×ŠE |  |
| ZATU651×X |  |
| ZATU651×ZAR |  |

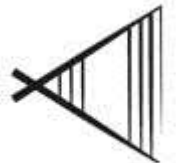
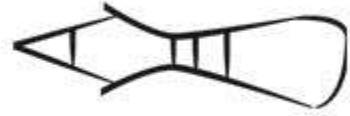
| Sign Name | Non-Numerical Sign Form |
|----------------|---|
| ZATU659 |  |
| ZATU659×1 |  |
| ZATU659×1 |  |
| ZATU659×1-tenû |  |

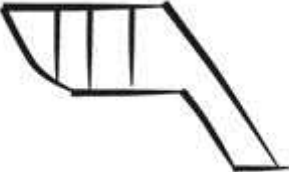
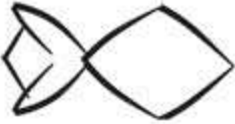
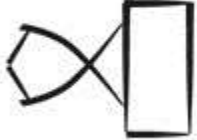



| Sign Name | Non-Numerical Sign Form |
|-----------|---|
| ZATU662 |  |

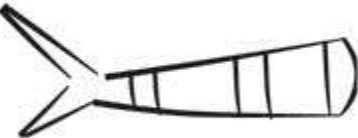
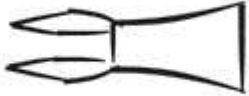

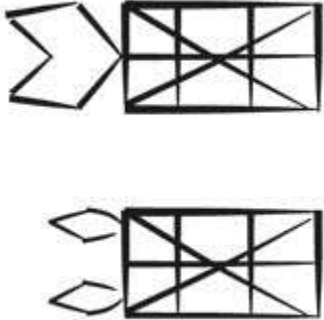
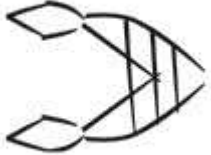
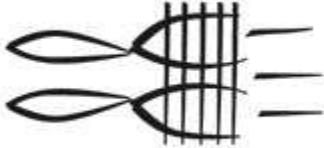
| Sign Name | Non-Numerical Sign Form |
|-----------|---|
| ZATU662×1 |  |
| ZATU664 |  |
| ZATU665 |  |

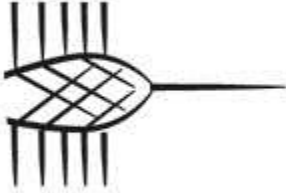

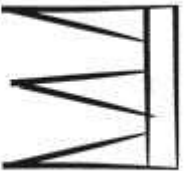
| Sign Name | Non-Numerical Sign Form |
|-----------|---|
| ZATU666 |  |
| ZATU667 |  |
| ZATU668 |  |
| ZATU669 |  |

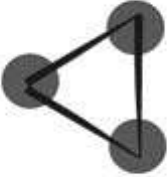

| Sign Name | Non-Numerical Sign Form |
|-----------|---|
| ZATU670 |  |
| ZATU672 |  |
| ZATU674 |  |
| ZATU675 |  |



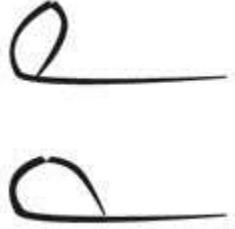

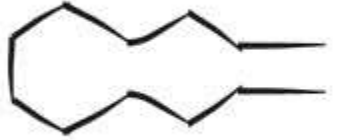
| Sign Name | Non-Numerical Sign Form |
|-----------|--|
| ZATU675 |  |
| ZATU675 |  |
| ZATU675 |  |

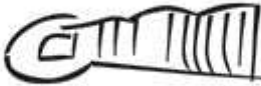
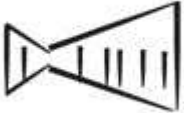

| Sign Name | Non-Numerical Sign Form |
|-----------|---|
| ZATU676 |  |
| ZATU676 |  |
| ZATU677 |  |
| ZATU677 |  |



| Sign Name | Non-Numerical Sign Form |
|-----------|--|
| ZATU678 |  |
| ZATU679 |  |
| ZATU680 |  |
| ZATU680 |  |

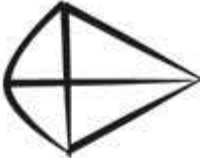

| Sign Name | Non-Numerical Sign Form |
|-----------|--|
| ZATU680 |  |
| ZATU680 |  |
| ZATU680 |  |
| ZATU681 |  |

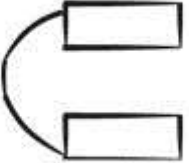
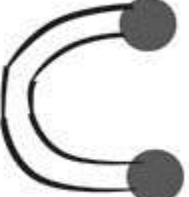

| Sign Name | Non-Numerical Sign Form |
|--------------|---|
| ZATU682 |  |
| ZATU683-tenû |  |
| ZATU683 |  |
| ZATU683 |  |

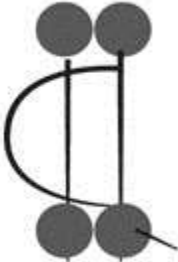

| Sign Name | Non-Numerical Sign Form |
|-----------|---|
| ZATU684 |  |
| ZATU685 |  |
| ZATU686 |  |
| ZATU686 |  |



| Sign Name | Non-Numerical Sign Form |
|-----------|---|
| ZATU686 |  |
| ZATU687 |  |
| ZATU688 |  |
| ZATU688 |  |



| Sign Name | Non-Numerical Sign Form |
|-----------|--|
| ZATU689 |  |
| ZATU690 |  |
| ZATU691 |  |

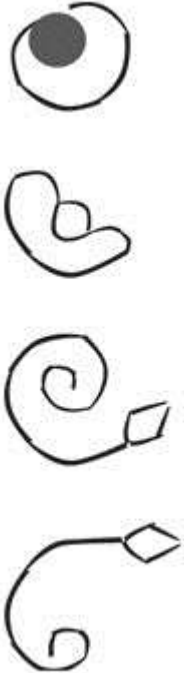

| Sign Name | Non-Numerical Sign Form |
|-----------|--|
| ZATU692 |  |
| ZATU693 |  |

| Sign Name | Non-Numerical Sign Form |
|--------------|---|
| ZATU693-tenû |  |
| ZATU694 |  |
| ZATU694 |  |

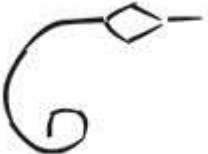
| Sign Name | Non-Numerical Sign Form |
|--------------|---|
| ZATU694 |  |
| ZATU694 |  |
| ZATU694-tenû |  |

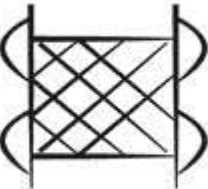

| Sign Name | Non-Numerical Sign Form |
|-----------|---|
| ZATU697 |  |
| ZATU697 |  |

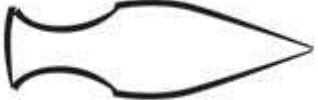

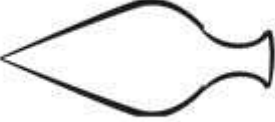
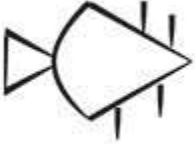
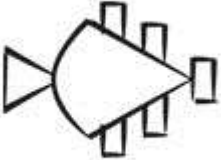
| Sign Name | Non-Numerical Sign Form |
|-----------|---|
| ZATU697 |  |
| ZATU699 |  |
| ZATU699 |  |
| ZATU700 |  |

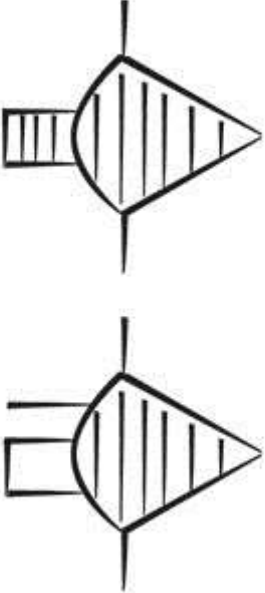

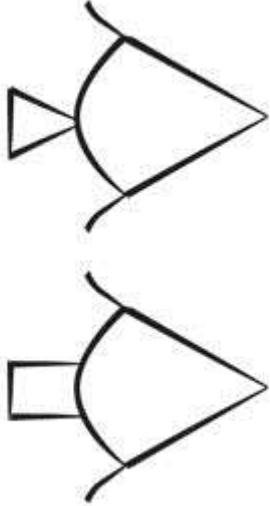
| Sign Name | Non-Numerical Sign Form |
|-----------|---|
| ZATU704 |  |
| ZATU705 |  |
| ZATU706 |  |
| ZATU707 |  |



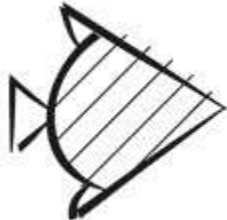

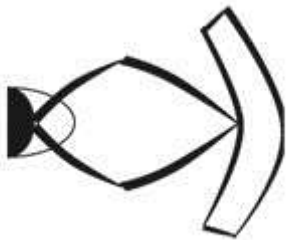
| Sign Name | Non-Numerical Sign Form |
|-----------|---|
| ZATU707 |  |
| ZATU708 |  |
| ZATU709 |  |

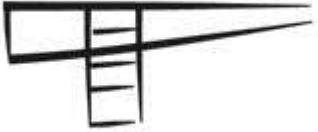

| Sign Name | Non-Numerical Sign Form |
|-----------|---|
| ZATU710 |  |

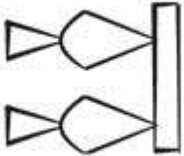
| Sign Name | Non-Numerical Sign Form |
|------------------------|--|
| <p>ZATU711</p> |  |
| <p>ZATU711×ḤI-gunû</p> |  |

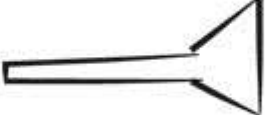

| Sign Name | Non-Numerical Sign Form |
|------------|---|
| ZATU711×X |  |
| ZATU713 |  |
| ZATU714 |  |
| ZATU714.RU |  |

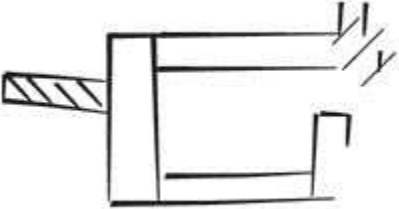
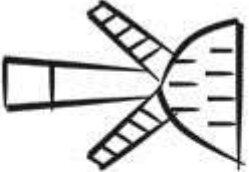
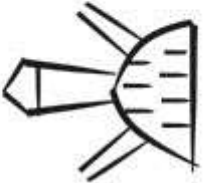
| Sign Name | Non-Numerical Sign Form |
|-----------------|---|
| ZATU714×ḤI-gunû |  |
| ZATU714×X |  |
| ZATU717 |  |
| ZATU718 |  |

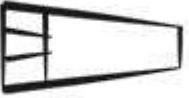
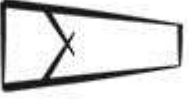
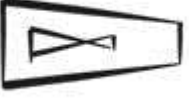
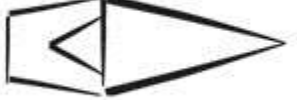

| Sign Name | Non-Numerical Sign Form |
|-----------|---|
| ZATU719 |  |
| ZATU720 |  |
| ZATU721 |  |
| ZATU722 |  |
| ZATU723 |  |

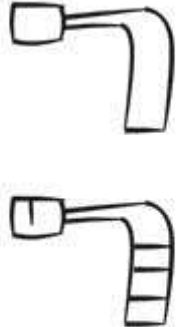
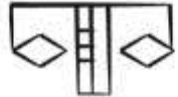
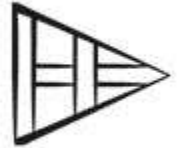

| Sign Name | Non-Numerical Sign Form |
|-----------|---|
| ZATU724 |  |
| ZATU725 |   |
| ZATU726 |  |

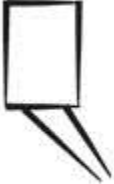

| Sign Name | Non-Numerical Sign Form |
|-----------|--|
| ZATU726 |  |
| ZATU726 |  |
| ZATU727 |  |
| ZATU728 |  |

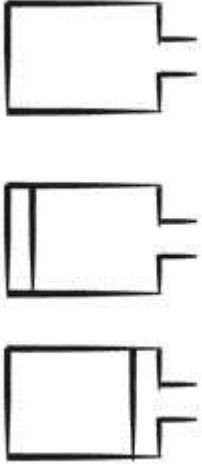

| Sign Name | Non-Numerical Sign Form |
|-----------|---|
| ZATU729 |  |
| ZATU730 |  |
| ZATU732 |  |
| ZATU733 |  |

| Sign Name | Non-Numerical Sign Form |
|-----------|---|
| ZATU734 |  |
| ZATU735 |  |

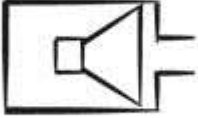
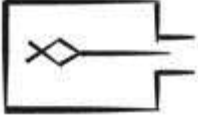

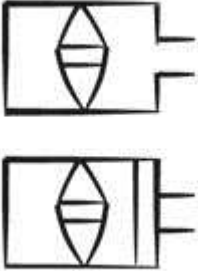

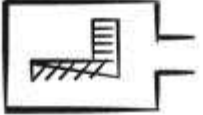
| Sign Name | Non-Numerical Sign Form |
|-----------|---|
| ZATU735 |  |
| ZATU735 |  |

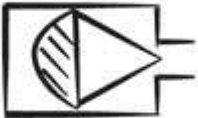
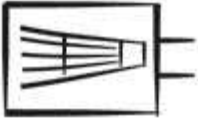
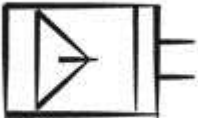
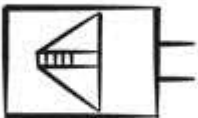
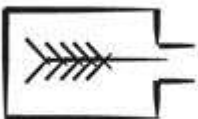

| Sign Name | Non-Numerical Sign Form |
|-----------|--|
| ZATU736 |  |
| ZATU736 |  |
| ZATU737 |  |

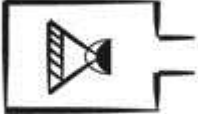
| Sign Name | Non-Numerical Sign Form |
|-------------|--|
| ZATU737×AB |  |
| ZATU737×BU |  |
| ZATU737×BUR |  |
| ZATU737×DI |  |

| Sign Name | Non-Numerical Sign Form |
|-------------|--|
| ZATU737×E |  |
| ZATU737×EN |  |
| ZATU737×EN |  |
| ZATU737×GAR |  |

| Sign Name | Non-Numerical Sign Form |
|-----------------|---|
| ZATU737×NI-gunû |  |
| ZATU737×NIMGIR |  |
| ZATU737×SAL |  |
| ZATU737×SU |  |
| ZATU737×ŠE |  |

| Sign Name | Non-Numerical Sign Form |
|------------------------|---|
| ZATU737×ŠITA-gunû |  |
| ZATU737×ŠITA |  |
| ZATU737×U ₄ |  |
| ZATU737×UNUG |  |
| ZATU737×X |  |

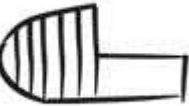

| Sign Name | Non-Numerical Sign Form |
|-----------|---|
| ZATU749 |  |
| ZATU749 |  |
| ZATU749 |  |



Sign Name

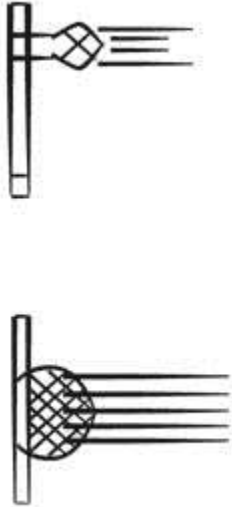

Non-Numerical Sign Form





ZATU750



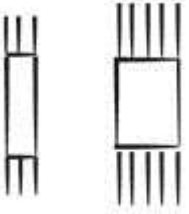





| Sign Name | Non-Numerical Sign Form |
|-----------|---|
| ZATU752 |  |
| ZATU753 |  |
| ZATU754 |  |



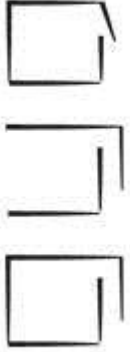

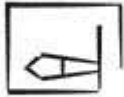
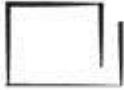
| Sign Name | Non-Numerical Sign Form |
|-----------|--|
| ZATU755 |  |
| ZATU755 |  |
| ZATU756 |  |

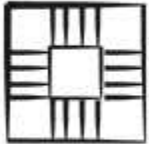

| Sign Name | Non-Numerical Sign Form |
|-----------|---|
| ZATU757 |  |
| ZATU758 |  |
| ZATU759 |  |

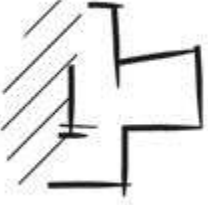

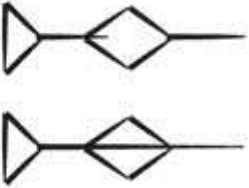
| Sign Name | Non-Numerical Sign Form |
|---|---|
| ZATU759-tenû×X |  |
| ZATU759×KU ₆ |  |
| ZATU759×(KU ₆ +KU ₆) |  |
| ZATU759×KU ₆ |  |

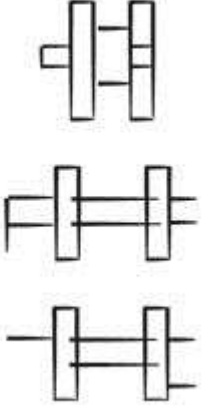
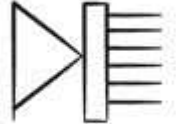

| Sign Name | Non-Numerical Sign Form |
|-----------|--|
| ZATU759×X |  |
| ZATU761 |  |
| ZATU762 |  |

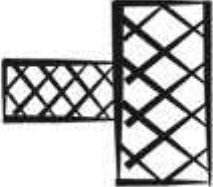
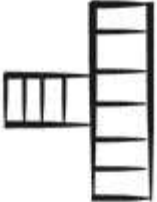

| Sign Name | Non-Numerical Sign Form |
|-------------|---|
| ZATU762×NIM |  |
| ZATU762 |  |
| ZATU762×AB |  |
| ZATU764 |  |
| ZATU765 |  |



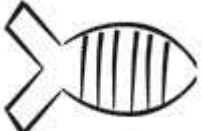
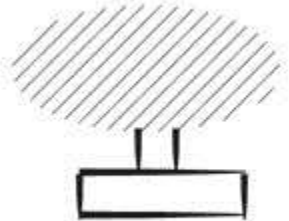

| Sign Name | Non-Numerical Sign Form |
|-----------|---|
| ZATU771 |  |
| ZATU772 |  |
| ZATU773 |  |
| ZATU773 |  |



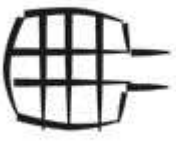

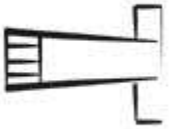
| Sign Name | Non-Numerical Sign Form |
|-----------|---|
| ZATU777 |  |
| ZATU778 |  |
| ZATU779 |  |



| Sign Name | Non-Numerical Sign Form |
|-----------|---|
| ZATU780 |  |
| ZATU781 |  |
| ZATU782 |  |
| ZATU783 |  |

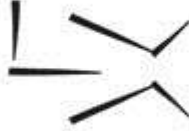

| Sign Name | Non-Numerical Sign Form |
|-----------|---|
| ZATU784 |  |
| ZATU785 |  |
| ZATU786 |  |
| ZATU787 |  |



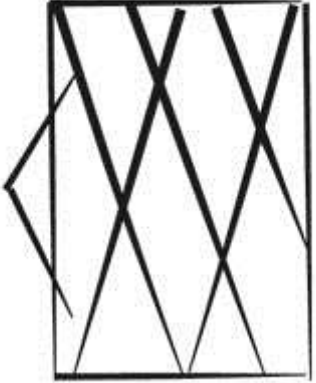

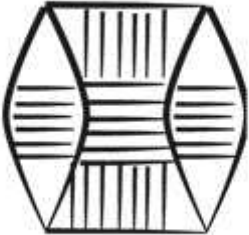
| Sign Name | Non-Numerical Sign Form |
|-----------|---|
| ZATU788 |  |
| ZATU789 |  |
| ZATU791 |  |
| ZATU792 |  |

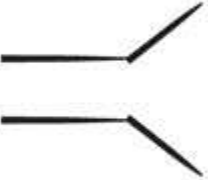
| Sign Name | Non-Numerical Sign Form |
|-----------|---|
| ZATU795 |  |
| ZATU797 |  |
| ZATU798 |  |
| ZATU799 |  |
| ZATU800 |  |

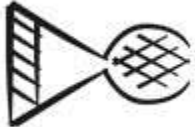
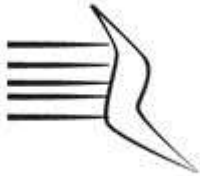

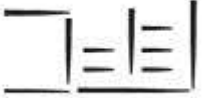
| Sign Name | Non-Numerical Sign Form |
|-----------|---|
| ZATU801 |  |
| ZATU802 |  |
| ZATU803 |  |
| ZATU804 |  |

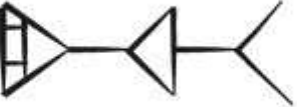
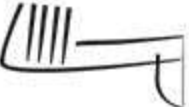
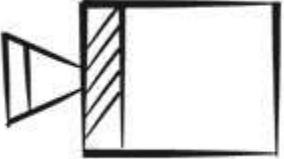
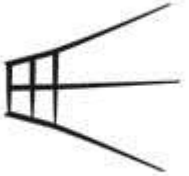

| Sign Name | Non-Numerical Sign Form |
|-----------|---|
| ZATU805 |  |
| ZATU806 |  |
| ZATU807 |  |

| Sign Name | Non-Numerical Sign Form |
|-----------|---|
| ZATU808 |  |
| ZATU809 |  |
| ZATU810 |  |
| ZATU811 |  |

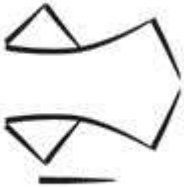

| Sign Name | Non-Numerical Sign Form |
|-----------|---|
| ZATU812 |  |
| ZATU813 |  |
| ZATU814 |  |
| ZATU815 |  |

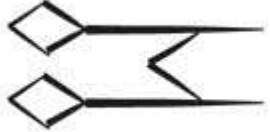

| Sign Name | Non-Numerical Sign Form |
|-----------|--|
| ZATU821 |  |
| ZATU822 |  |
| ZATU823 |  |
| ZATU824 |  |

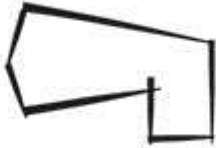
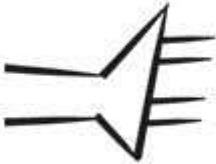
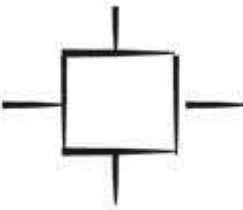
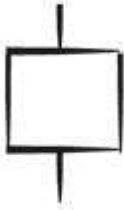

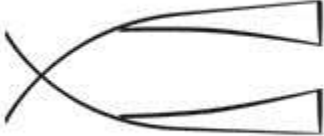
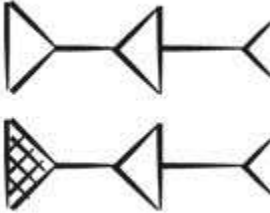
| Sign Name | Non-Numerical Sign Form |
|-----------|---|
| ZATU825 |  |
| ZATU826 |  |
| ZATU829 |  |
| ZATU831 |  |

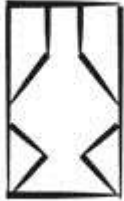

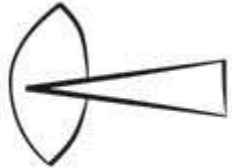
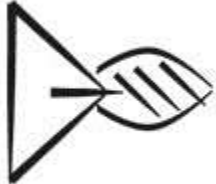
| Sign Name | Non-Numerical Sign Form |
|--------------|---|
| ZATU831-gunû |  |
| ZATU832 |  |
| ZATU833 |  |
| ZATU834 |  |

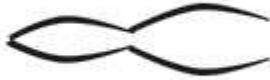

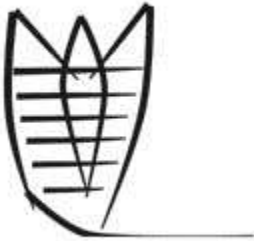
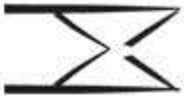
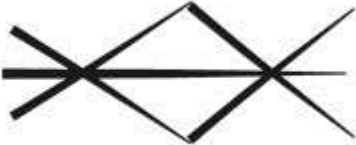
| Sign Name | Non-Numerical Sign Form |
|-----------|---|
| ZATU835 |  |
| ZATU836 |  |
| ZATU837 |  |
| ZATU837 |  |

| Sign Name | Non-Numerical Sign Form |
|-----------|---|
| ZATU838 |  |
| ZATU839 |  |
| ZATU840 |  |
| ZATU841 |  |

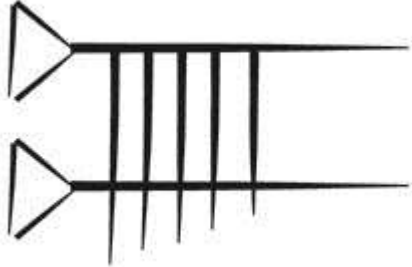

| Sign Name | Non-Numerical Sign Form |
|-----------|---|
| ZATU842 |  |
| ZATU843 |  |
| ZATU844 |  |
| ZATU845 |  |

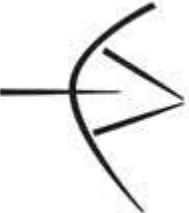

| Sign Name | Non-Numerical Sign Form |
|-----------|---|
| ZATU846 |  |
| ZATU847 |  |
| ZATU848 |  |
| ZATU849 |  |

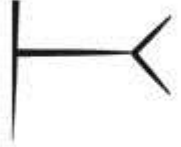
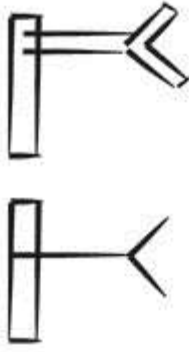
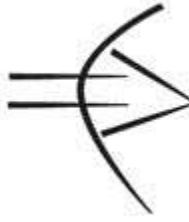

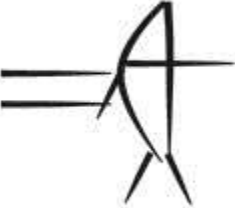
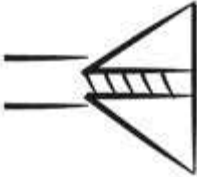
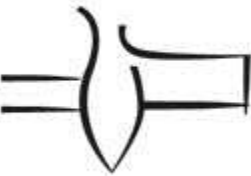
| Sign Name | Non-Numerical Sign Form |
|-----------|--|
| ZATU853 |  |
| ZATU854 |  |
| ZATU855 |  |

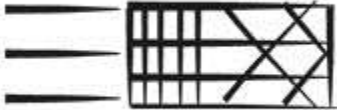
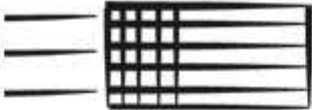

| Sign Name | Non-Numerical Sign Form |
|-----------|--|
| 1 . ÁB |  |
| 1 . ŠÁĤ |  |
| 1 . ŠUBUR |  |

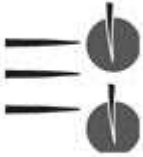

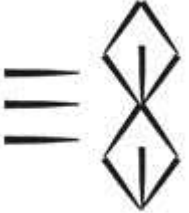

| Sign Name | Non-Numerical Sign Form |
|-----------|--|
| 1 . BAD |  |
| 1 . BAD |  |
| 2 . ÁB |  |

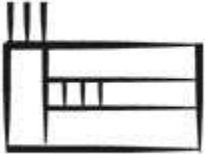
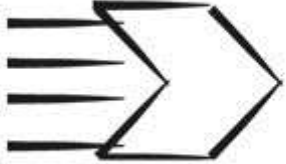

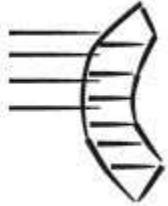
| Sign Name | Non-Numerical Sign Form |
|---------------------|---|
| 2 . KU ₆ |  |
| 2 . SU |  |
| 2 . ŠUBUR |  |
| 3 . AMAR |  |

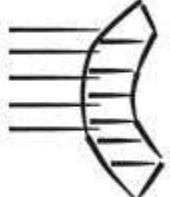

| Sign Name | Non-Numerical Sign Form |
|-----------|---|
| 3 . BÀRA |  |
| 3 . É |  |
| 3 . GAR |  |
| 3 . NUNUZ |  |



| Sign Name | Non-Numerical Sign Form |
|-----------|--|
| 3 . NUNUZ |  |
| 3 . PIRIG |  |
| 3 . ŠUBUR |  |

| Sign Name | Non-Numerical Sign Form |
|-----------|---|
| 3 . ÛR |  |
| 4 . AMAR |  |
| 4 . GAR |  |
| 4 . KÙ |  |

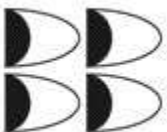

| Sign Name | Non-Numerical Sign Form |
|-----------|---|
| 4 . NI |  |
| 5 . GAR |  |
| 5 . KÙ |  |
| 6 . GAR |  |

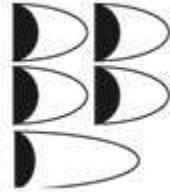
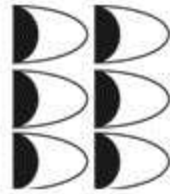
| Sign Name | Non-Numerical Sign Form |
|-----------|---|
| 6 . KÙ |  |
| 8 . NI |  |

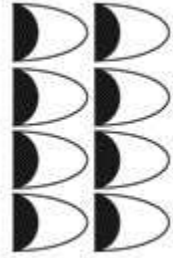
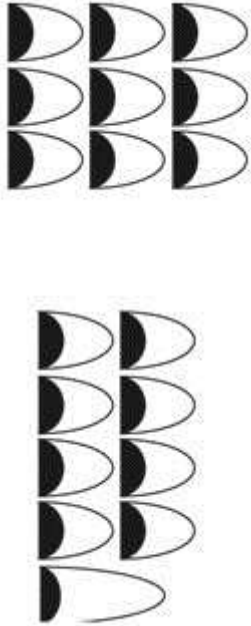

| Sign Name | Numerical Sign Form |
|-----------|--|
| 1 |  |
| 2 |  |
| 3 |  |
| 4 |  |

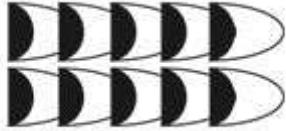

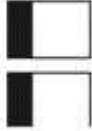
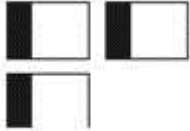
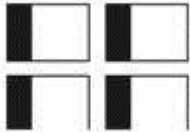
| Sign Name | Numerical Sign Form |
|-----------|--|
| 5 |  |
| 6 |  |
| 7 |  |

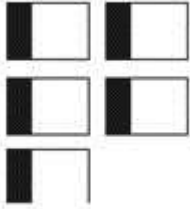
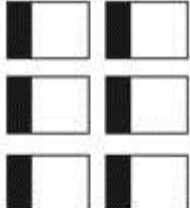
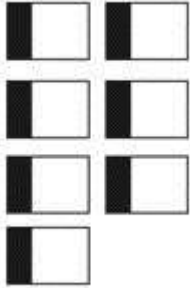
| Sign Name | Numerical Sign Form |
|-----------|--|
| 8 |  |
| 9 |  |

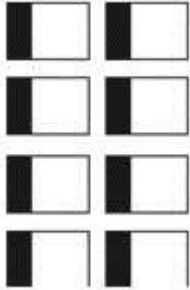
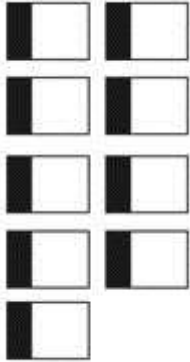
| Sign Name | Numerical Sign Form |
|-----------|---|
| 10 |  |
| 1-flat |  |
| 2-flat |  |
| 3-flat |  |
| 4-flat |  |

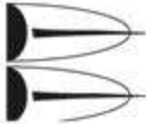

| Sign Name | Numerical Sign Form |
|-----------|--|
| 5-flat |  |
| 6-flat |  |
| 7-flat |  |

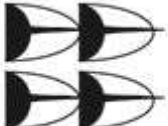

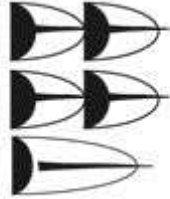
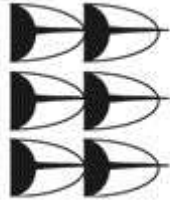
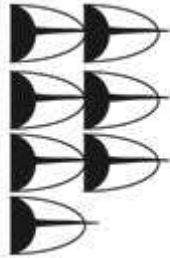

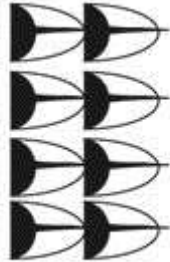
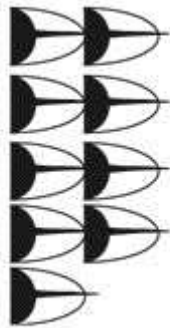
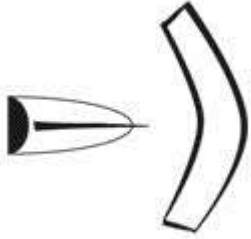
| Sign Name | Numerical Sign Form |
|------------------------|---|
| 8-flat |  |
| 9-flat |  |
| 1-vertically reflected |  |

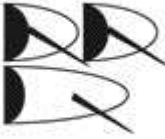
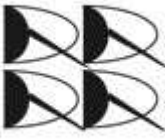

| Sign Name | Numerical Sign Form |
|-----------|--|
| 1 |  |
| 2 |  |
| 3 |  |
| 4 |  |

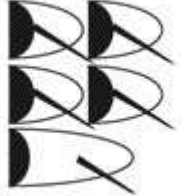
| Sign Name | Numerical Sign Form |
|-----------|--|
| 5 |  |
| 6 |  |
| 7 |  |

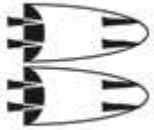

| Sign Name | Numerical Sign Form |
|-----------|---|
| 8 |  |
| 9 |  |
| 1 . RU |  |

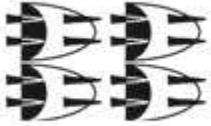
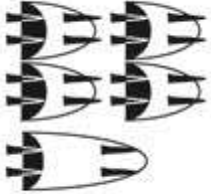

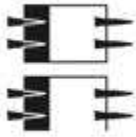
| Sign Name | Numerical Sign Form |
|-----------|--|
| 1 |  |
| 2 |  |
| 3 |  |
| 4 |  |

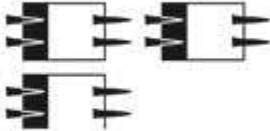
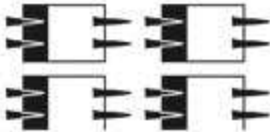
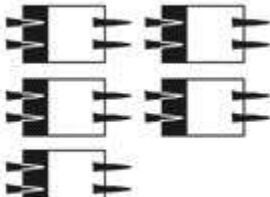
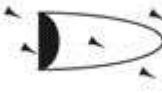

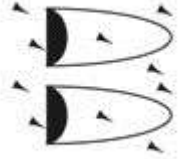
| Sign Name | Numerical Sign Form |
|-----------|--|
| 5 |  |
| 1 |  |
| 2 |  |
| 3 |  |

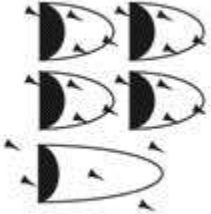

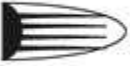

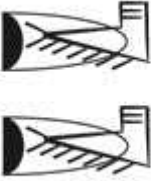
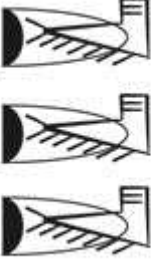
| Sign Name | Numerical Sign Form |
|-----------|--|
| 4 |  |
| 5 |  |
| 1-flat |  |
| 2-flat |  |

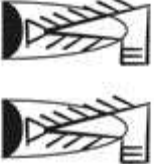
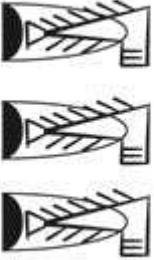

| Sign Name | Numerical Sign Form |
|-----------|---|
| 3-flat |  |
| 4-flat |  |
| 5-flat |  |
| 1 |  |





| Sign Name | Numerical Sign Form |
|-----------|---|
| 2 |  |
| 3 |  |
| 4 |  |
| 5 |  |



| Sign Name | Numerical Sign Form |
|-----------|--|
| 1 |  |
| 1 |  |
| 2 |  |
| 3 |  |



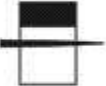

| Sign Name | Numerical Sign Form |
|-----------|---|
| 1 |  |
| 2 |  |
| 3 |  |
| 1 |  |





| Sign Name | Numerical Sign Form |
|-----------|---|
| 2 |  |
| 3 |  |
| 4 |  |
| 5 |  |

| Sign Name | Numerical Sign Form |
|-----------|--|
| 6 |  |
| 7 |  |
| 8 |  |



| Sign Name | Numerical Sign Form |
|-----------|---|
| 9 |  |
| 1-flat |  |
| 1-flat×1 |  |
| 1 |  |



| Sign Name | Numerical Sign Form |
|-----------|--|
| 2 |  |
| 3 |  |
| 4 |  |

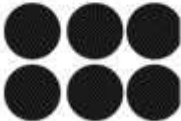

| Sign Name | Numerical Sign Form |
|-----------|---|
| 4 |  |
| 1 |  |
| 1 |  |
| 1 |  |



| Sign Name | Numerical Sign Form |
|-----------|--|
| 1 |  |
| 2 |  |
| 3 |  |
| 4 |  |



| Sign Name | Numerical Sign Form |
|-----------|---|
| 5 |  |

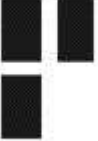

| Sign Name | Numerical Sign Form |
|-----------|--|
| 6 |   |
| 7 |  |



| Sign Name | Numerical Sign Form |
|-----------|---|
| 8 |  |
| 9 |  |
| 10 |  |

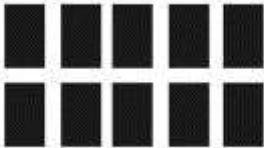

| Sign Name | Numerical Sign Form |
|-----------|---|
| 12 |  |
| 1-flat |  |
| 2-flat |  |
| 3-flat |  |

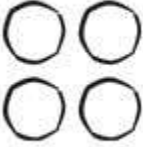
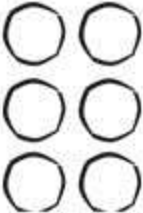

| Sign Name | Numerical Sign Form |
|-----------|--|
| 4-flat |  |
| 5-flat |  |
| 6-flat |  |

| Sign Name | Numerical Sign Form |
|-----------|---|
| 7-flat |  |
| 8-flat |  |

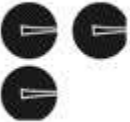
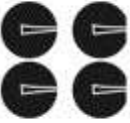
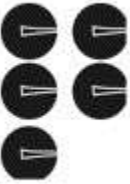
| Sign Name | Numerical Sign Form |
|-----------|---|
| 9-flat |  |
| 10-flat |  |
| 2 (LAGAB) |  |

| Sign Name | Numerical Sign Form |
|-----------|---|
| 4 (LAGAB) |  |
| 6 (LAGAB) |  |
| 1 |  |
| 2 |  |

| Sign Name | Numerical Sign Form |
|-----------|---|
| 3 |  |
| 4 |  |
| 5 |  |
| 1 |  |
| 1 |  |

| Sign Name | Numerical Sign Form |
|-----------|--|
| 5 |  |
| 6 |  |
| 7 |  |

Sign Name





Numerical Sign Form

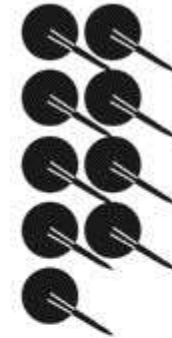

8



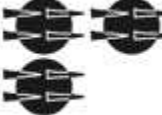
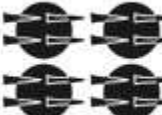

9



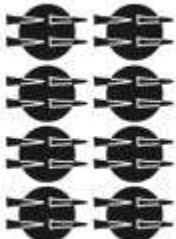

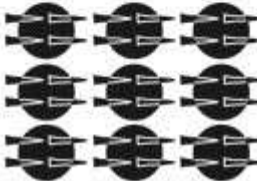

| Sign Name | Numerical Sign Form |
|-----------|---|
| 1 |  |
| 2 |  |
| 3 |  |
| 4 |  |
| 5 |  |

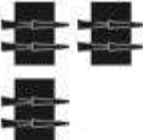
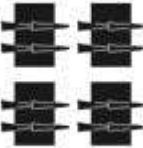
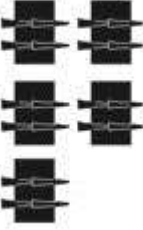
| Sign Name | Numerical Sign Form |
|-----------|--|
| 6 |  |
| 7 |  |
| 8 |  |

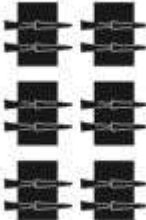
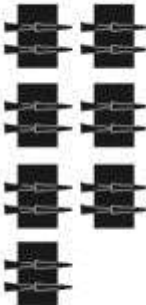
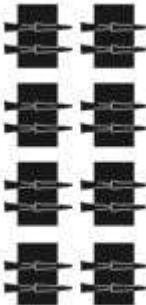

| Sign Name | Numerical Sign Form |
|---|--|
| <p data-bbox="701 548 736 591">9</p> |   |
| <p data-bbox="602 1040 835 1089">1-flat</p> |  |



| Sign Name | Numerical Sign Form |
|-----------|---|
| 2-flat |  |
| 3-flat |  |
| 4-flat |  |
| 5-flat |  |

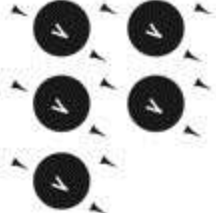
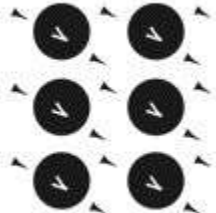

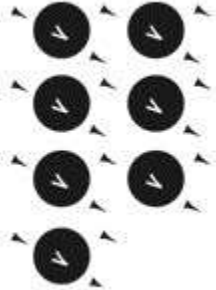

| Sign Name | Numerical Sign Form |
|-----------|---|
| 6-flat |  |
| 7-flat |  |
| 8-flat |  |

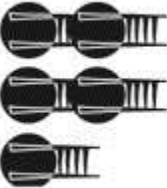

| Sign Name | Numerical Sign Form |
|-----------|---|
| 9-flat |  |
| 1 |  |
| 2 |  |
| 3 |  |

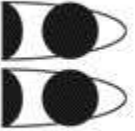

| Sign Name | Numerical Sign Form |
|-----------|--|
| 4 |  |
| 5 |  |
| 6 |  |

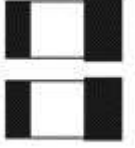

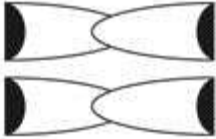
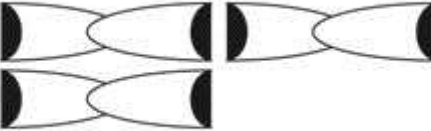

| Sign Name | Numerical Sign Form |
|-----------|--|
| 7 |  |
| 8 |  |
| 9 |  |

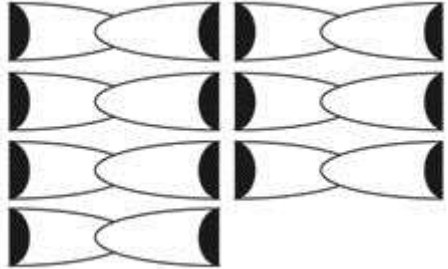

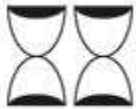
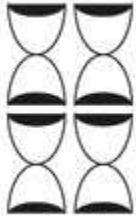

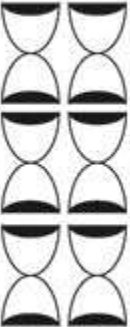
| Sign Name | Numerical Sign Form |
|-----------|--|
| 2 |  |
| 3 |  |
| 4 |  |
| 5 |  |





| Sign Name | Numerical Sign Form |
|-----------|---|
| 6 |  |
| 1 |  |
| 2 |  |
| 1-flat |  |
| 2-flat |  |



| Sign Name | Numerical Sign Form |
|-----------|--|
| 1 |  |
| 2 |  |
| 3 |  |
| 5 |  |



| Sign Name | Numerical Sign Form |
|-----------|---|
| 7 |  |
| 1 |  |
| 2 |  |
| 4 |  |



| Sign Name | Numerical Sign Form |
|-----------|---|
| 6 |  |
| 1-flat |  |
| 1 |  |
| 1 |  |

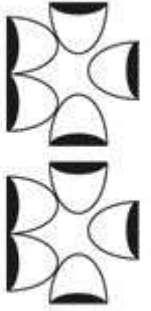

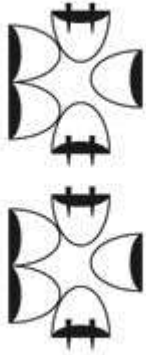

| Sign Name | Numerical Sign Form |
|-----------|--|
| 1 |  |
| 1 |   |
| 1 |  |

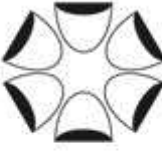
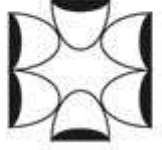



| Sign Name | Numerical Sign Form |
|-----------|--|
| 1 |   |
| 1 |  |
| 1 |  |

| Sign Name | Numerical Sign Form |
|-----------|--|
| 1 |  |
| 1 |   |
| 2 |  |

| Sign Name | Numerical Sign Form |
|-----------|--|
| 1 |  |
| 1 |  |
| 2 |  |



| Sign Name | Numerical Sign Form |
|-----------|--|
| 1 |  |
| 1 |   |
| 1 |  |

| Sign Name | Numerical Sign Form |
|-----------|---|
| 1 |  |
| 1 |  |
| 1 |  |
| 1 |  |

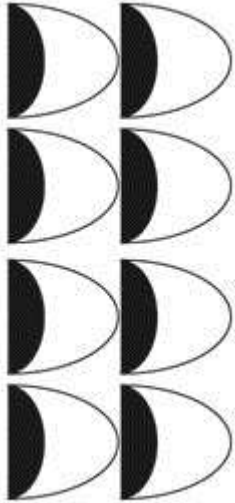
| Sign Name | Numerical Sign Form |
|-----------|---|
| 1 |  |
| 1 |  |
| 1 |  |
| 1 |  |

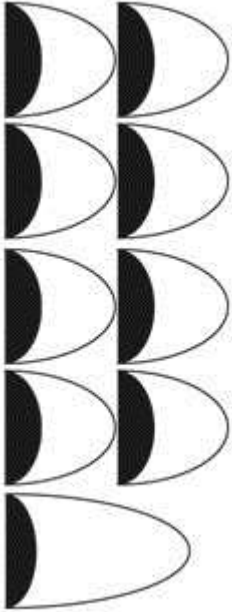
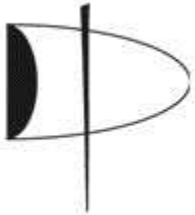

| Sign Name | Numerical Sign Form |
|-----------|---|
| 8 |  |

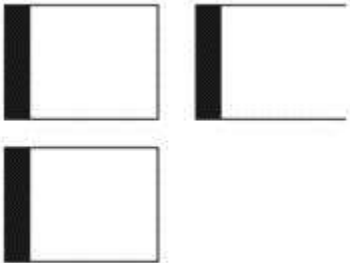
| Sign Name | Numerical Sign Form |
|--|--|
| <p data-bbox="701 509 736 558">9</p> |  |
| <p data-bbox="661 1045 774 1094">1×1</p> |  |

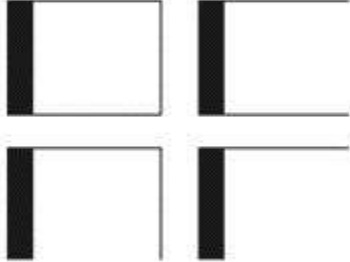
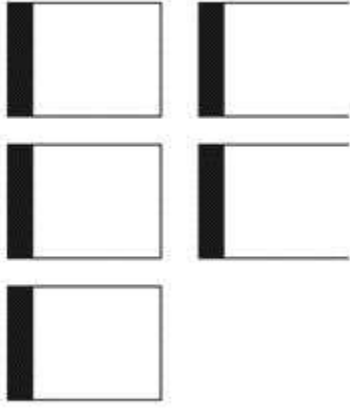
| Sign Name | Numerical Sign Form |
|-----------|--|
| 1-flat |  |
| 2-flat |  |
| 3-flat |  |

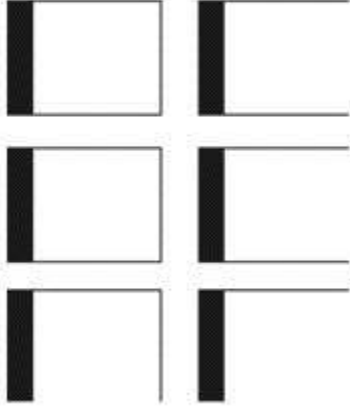
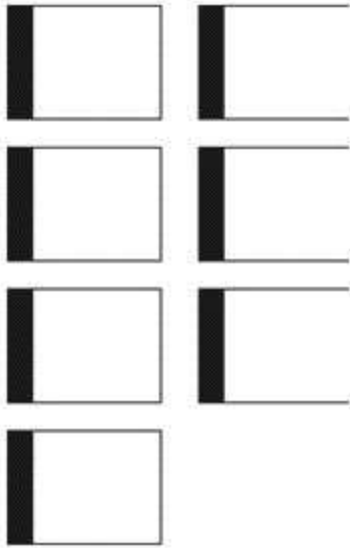
| Sign Name | Numerical Sign Form |
|-----------|--|
| 4-flat |  |
| 5-flat |  |

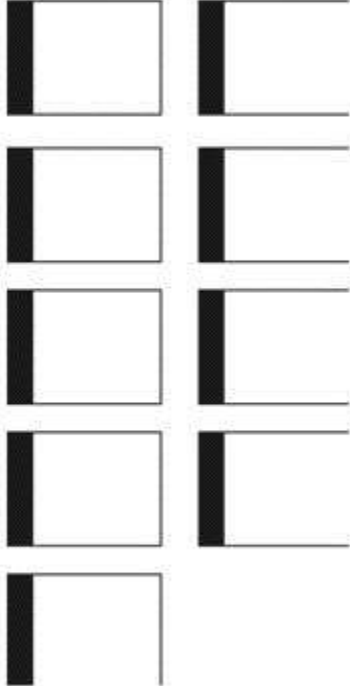
| Sign Name | Numerical Sign Form |
|-----------|--|
| 6-flat |  |
| 7-flat |  |

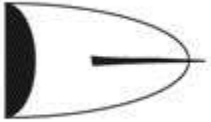
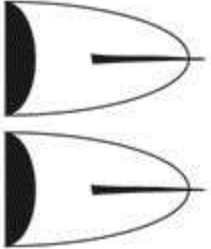
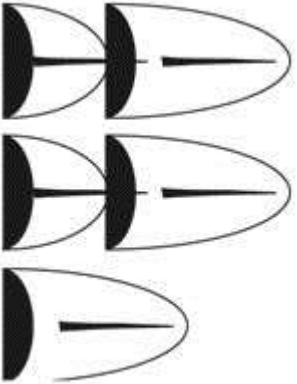

| Sign Name | Numerical Sign Form |
|---------------|---|
| <p>9-flat</p> |  |
| <p>1-tenû</p> |  |

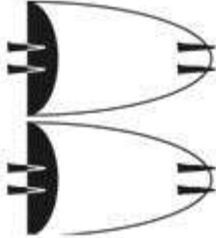
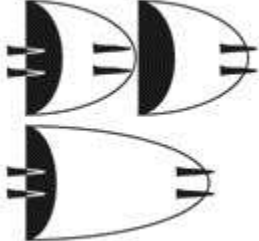

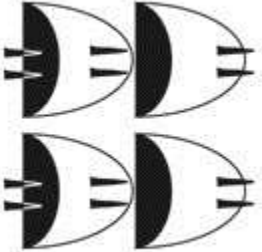
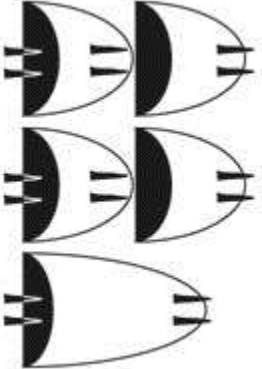
| Sign Name | Numerical Sign Form |
|-----------|--|
| 1 |  |
| 2 |  |
| 5 |  |

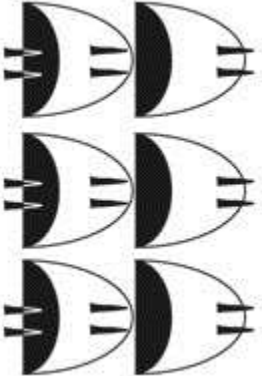
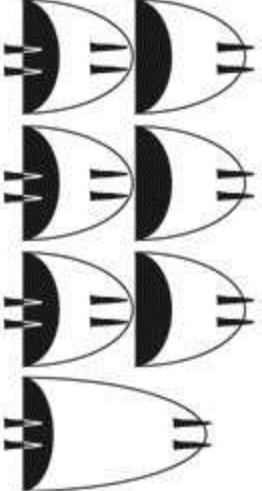

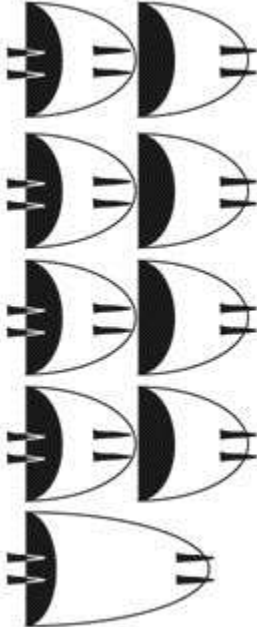

| Sign Name | Numerical Sign Form |
|-----------|--|
| 1 |  |
| 2 |  |
| 3 |  |

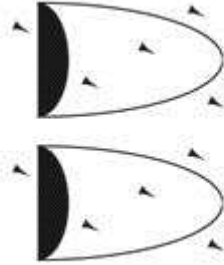
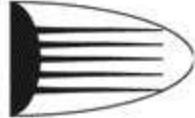



| Sign Name | Numerical Sign Form |
|-----------|---|
| 4 |  |
| 5 |  |





| Sign Name | Numerical Sign Form |
|-----------|--|
| 6 |  |
| 7 |  |





| Sign Name | Numerical Sign Form |
|-----------|---|
| 9 |  |
| 1-flat |  |
| 1 |  |



| Sign Name | Numerical Sign Form |
|-----------|---|
| 2 |  |
| 1 |  |
| 1 |  |
| 2 |  |





| Sign Name | Numerical Sign Form |
|-----------|---|
| 3 |  |
| 4 |  |
| 1 |  |
| 2 |  |

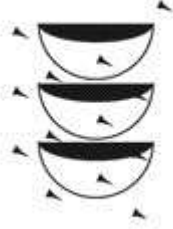
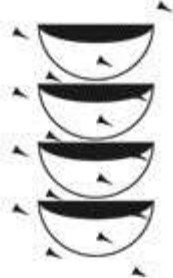



| Sign Name | Numerical Sign Form |
|-----------|---|
| 3 |  |
| 4 |  |
| 1 |  |
| 2 |  |

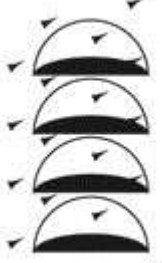

| Sign Name | Numerical Sign Form |
|-----------|---|
| 3 |  |
| 4 |  |
| 1 |  |
| 2 |  |

| Sign Name | Numerical Sign Form |
|-----------|---|
| 3 |  |
| 4 |  |
| 1 |  |
| 2 |  |



| Sign Name | Numerical Sign Form |
|-----------|--|
| 3 |  |
| 4 |  |
| 1 |  |

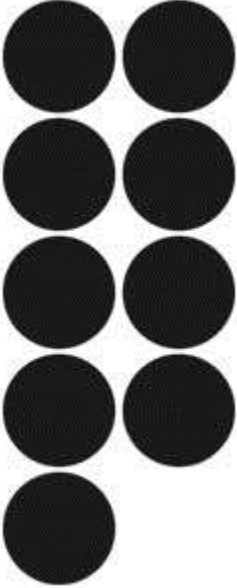

| Sign Name | Numerical Sign Form |
|-----------|---|
| 2 |  |
| 3 |  |
| 4 |  |
| 1 |  |

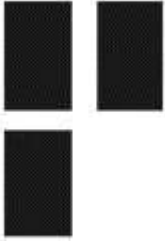
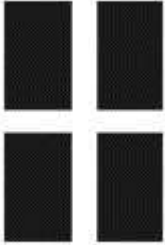

| Sign Name | Numerical Sign Form |
|-----------|--|
| 4 |  |
| 1 |  |
| 1 |  |
| 2 |  |

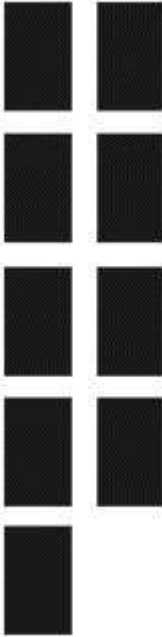

| Sign Name | Numerical Sign Form |
|-----------|--|
| 9 |  |
| 1-flat |  |

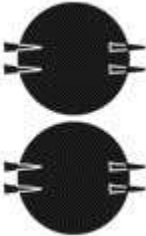
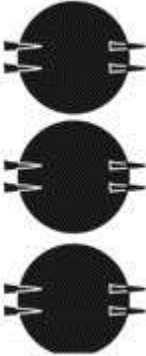

| Sign Name | Numerical Sign Form |
|-----------|--|
| 2-flat |  |
| 3-flat |  |
| 4-flat |  |

| Sign Name | Numerical Sign Form |
|-----------|--|
| 5-flat |  |
| 6-flat |  |

| Sign Name | Numerical Sign Form |
|-----------|---|
| 9-flat |  |
| 1 |  |
| 1 |  |

| Sign Name | Numerical Sign Form |
|-----------|---|
| 2 |  |
| 3 |  |
| 1-flat |  |

| Sign Name | Numerical Sign Form |
|-----------|--|
| 2-flat |  |
| 1 |  |
| 2 |  |

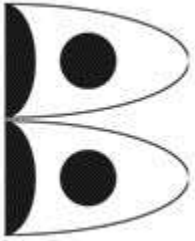
| Sign Name | Numerical Sign Form |
|-----------|--|
| 3 |  |
| 1 |  |
| 2 |  |

Sign Name

Numerical Sign Form

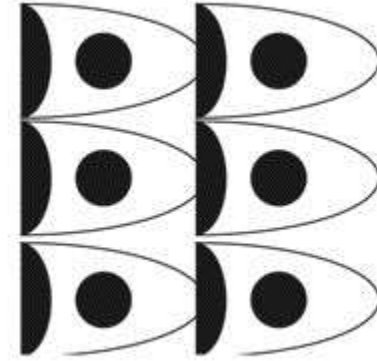

6



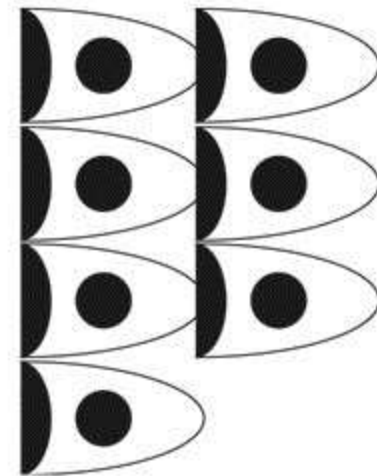

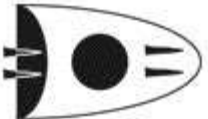
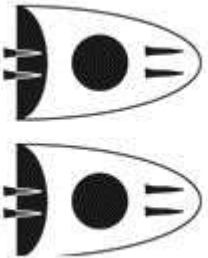
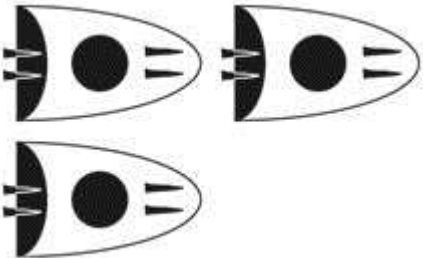
7

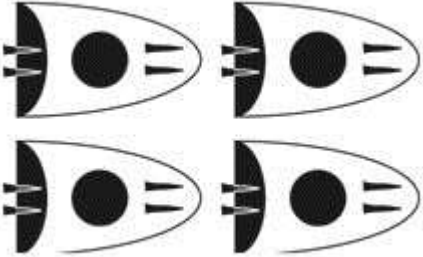
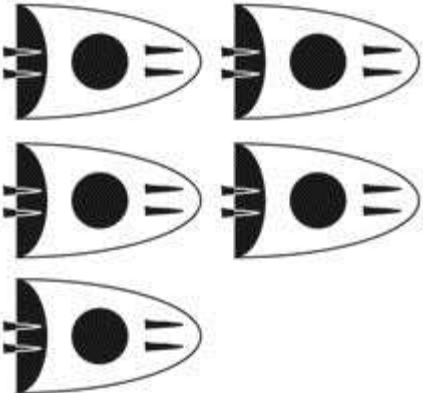

| Sign Name | Numerical Sign Form |
|-----------|---|
| 1-flat |  |
| 1 |  |
| 2 |  |
| 3 |  |

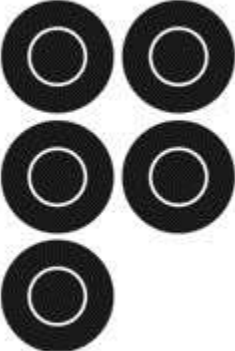
| Sign Name | Numerical Sign Form |
|-----------|---|
| 4 |  |
| 5 |  |
| 1 |  |

| Sign Name | Numerical Sign Form |
|-----------|--|
| 5 |  |
| 1 |  |
| 2 |  |

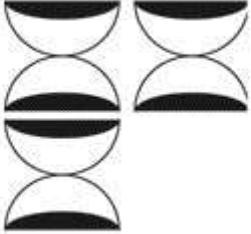
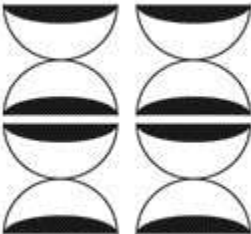
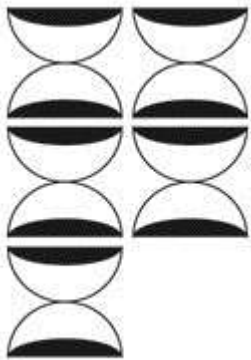
| Sign Name | Numerical Sign Form |
|-----------|--|
| 3 |  |
| 4 |  |
| 5 |  |

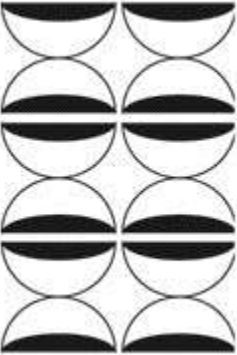
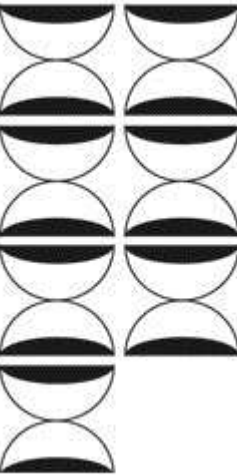
| Sign Name | Numerical Sign Form |
|-----------|--|
| 6 |  |
| 7 |  |

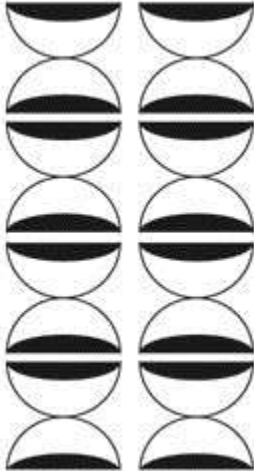
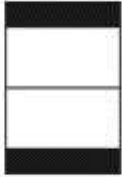
| Sign Name | Numerical Sign Form |
|-----------|--|
| 8 |  |
| 1-flat |  |

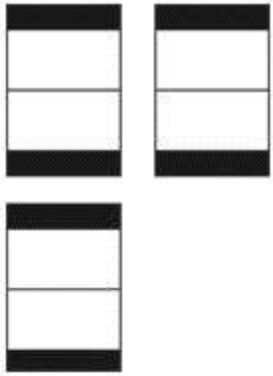
| Sign Name | Numerical Sign Form |
|-----------|--|
| 2-flat |  |
| 3-flat |  |

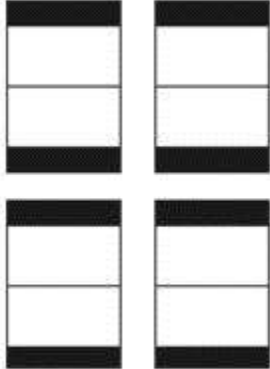
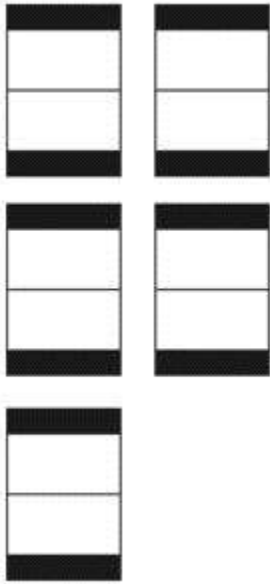
| Sign Name | Numerical Sign Form |
|-----------|--|
| 4-flat |  |
| 5-flat |  |

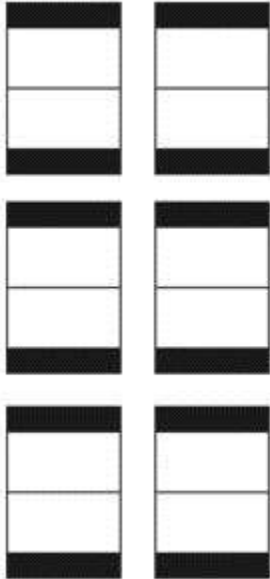
| Sign Name | Numerical Sign Form |
|-----------|---|
| 6-flat |  |

Sign Name

Numerical Sign Form

7-flat

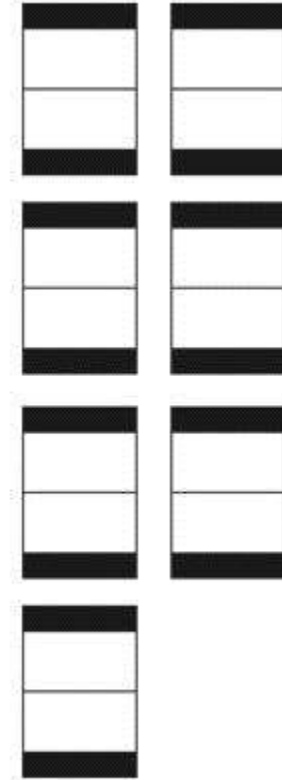

Sign Name

Numerical Sign Form

8-flat

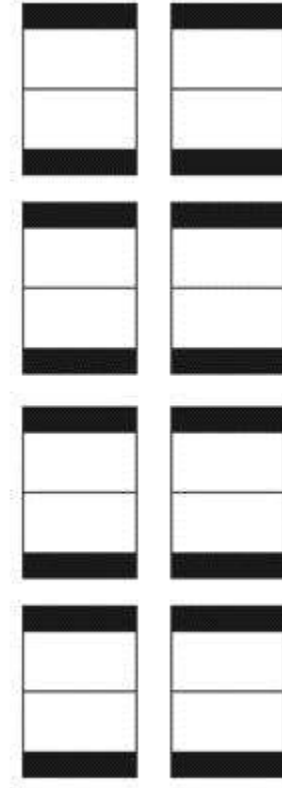



Sign Name

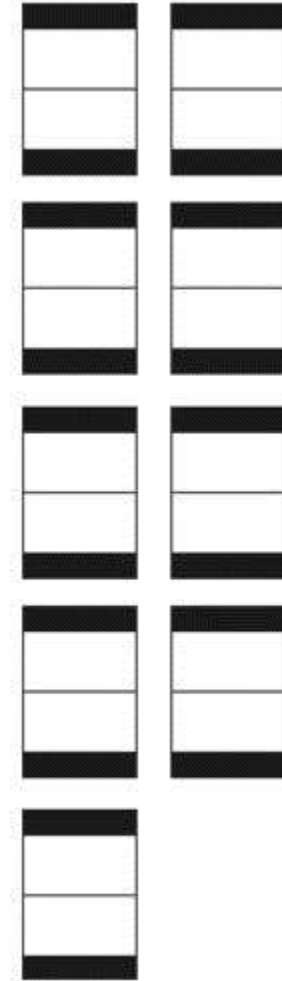

Numerical Sign Form

9-flat



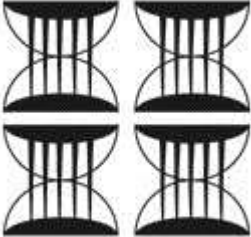
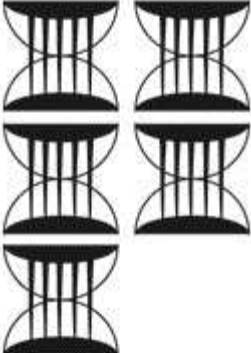

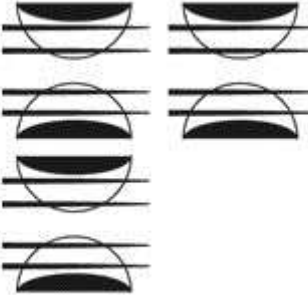
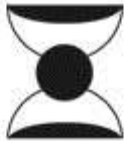



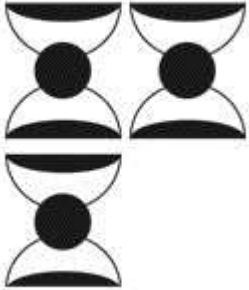
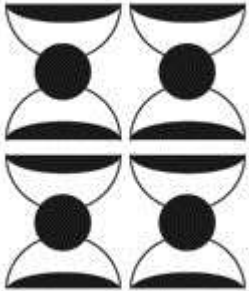

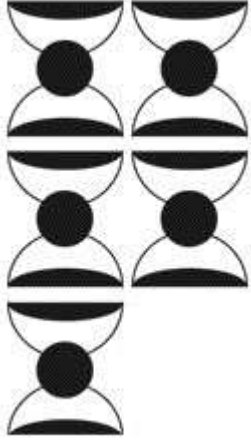
| Sign Name | Numerical Sign Form |
|-----------|--|
| 1 |  |
| 2 |  |
| 3 |  |



| Sign Name | Numerical Sign Form |
|-----------|---|
| 4 |  |
| 5 |  |





| Sign Name | Numerical Sign Form |
|-----------|--|
| 3 |  |
| 1 |  |
| 2 |  |

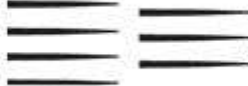

| Sign Name | Numerical Sign Form |
|-----------|---|
| 3 |  |
| 4 |  |





| Sign Name | Numerical Sign Form |
|-----------|---|
| 5 |  |
| 1 |  |
| 1 |  |



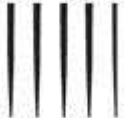
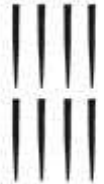

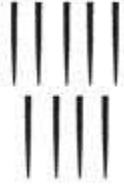
| Sign Name | Numerical Sign Form |
|-----------|---|
| 2 |  |
| 1.1 |  |
| 1 |  |
| 2 |  |
| 3 |  |



| Sign Name | Numerical Sign Form |
|-----------|---|
| 4 |  |
| 5 |  |
| 6 |  |
| 7 |  |

| Sign Name | Numerical Sign Form |
|-----------|---|
| 8 |  |
| 9 |  |
| 10 |  |
| 1 |  |
| 2 |  |

| Sign Name | Numerical Sign Form |
|-----------|--|
| 3 |  |
| 4 |  |
| 5 |  |
| 8 |  |

| Sign Name | Numerical Sign Form |
|-----------|---|
| 9 |  |
| 10 |  |
| 12 |  |
| 1-tenû |  |

| Sign Name | Numerical Sign Form |
|-----------|---|
| 2 |  |
| 3 |  |
| 4 |  |
| 1 |  |

| Sign Name | Numerical Sign Form |
|-----------|--|
| 3 |  |
| 4 |  |
| 1 |  |

References

- Bord, Lucien-Jean and Remo Mugnaioni. *L'Écriture Cunéiforme: Syllabaire Sumérien, Babylonien et Assyrien*. Paris: Librairie Orientaliste Paul Geuthner S.A., ©2002.
- Borger, Riekele, and Rykle Borger. *Mesopotamisches Zeichenlexikon*. Vol. 305. Ugarit Verlag Münster, ©2004.
- Borger, Rykle. *Assyrisch-babylonische Zeichenliste* (AOAT 33). Auflage. Neukirchen-Vluyn: Neukirchener Verlag, ©1978.
- Burrows, Eric. "Archaic Texts (UET 2)." *London, printed by order of the Trustees of the British Museum and the Museum of the University of Pennsylvania*, ©1935.
- Deimel, Anton. *Liste der archaischen Keilschriftzeichen von Fara*. JC Hinrich, ©1922.
- Ellermeier, Friedrich, and Riekele Borger. *Sumerisches Glossar: Führer durch die neuere sumerologische Fachliteratur. Die sumerischen Lautwerte: nach dem Alphabet, nach den "Zeichennamen" und nach den Keilschriftzeichen geordnet*. Selbstverlag dr. Friedrich Ellermeier, ©1979-©1980.
- Green, Margret W., and Hans J. Nissen. *Zeichenliste der archaischen Texte aus Uruk*. Mann, ©1987.
- Labat, René and Florence Malbran-Labat. *Manuel D'Épigraphie Akkadienne: Signes, Syllabaire, Idéogrammes*. 6th ed. Paris: Librairie Orientaliste Paul Geuthner S.A., ©1988.
- Miller, Douglas B. and R. Mark Shipp. *An Akkadian Handbook: Paradigms, Helps, Glossary, Logograms, and Sign List*. 2nd ed. Winona Lake, Ind.: Eisenbrauns, ©2014.
- Oracc Global Sign List*. Retrieved June 4th, 2017, from <http://oracc.museum.upenn.edu/ogsl/signlist/>
- Rosengarten, Yvonne. *Répertoire commenté des signes présargoniques sumériens de Lagaš*. E. de Boccard, ©1967.
- Rüster, Christel, and Erich Neu. *Hethitisches Zeichenlexikon: Inventar und Interpretation der Keilschriftzeichen aus den Boğazköy-Texten*. Vol. 2. Otto Harrassowitz Verlag, ©1989.
- Schneider, Nikolaus. *Die Keilschriftzeichen der Wirtschaftsurkunden von Ur III nebst ihren charakteristischsten Schreibvarianten: systematisch zusammengestellt*. Papstliches Bibelinstitut, ©1935.
- The Pennsylvania Sumerian Dictionary*. Retrieved June 4th, 2017, from <http://psd.museum.upenn.edu/epsd/nepsd-frame.html>
- Thureau-Dangin, François. *Recherches sur l'origine de l'écriture cunéiforme*. Vol. 1. E. Leroux, ©1898.